

Gazala: The Cauldron
After-Action Report
Dav Vandenbroucke
davanden@cox.net
April 17, 2014

This is an after-action report of a solitaire play-through of *Gazala: The Cauldron* by Revolution Games. This was my first time playing this game, although I had previously played another game about Gazala and another one using the same system as this game. The game is an operational treatment of the Battle of Gazala in Libya, 1942. Historically, the Axis side encountered some hard fighting but routed the Allies, taking Tobruk and driving them out of Libya.

Gazala: The Cauldron uses the same system as *Celles*. The heart of the system is the alternating chit-pull activations by formation. At the beginning of each turn, the two sides put activation chits in their cups as directed by a chart that gives the turn-by-turn allocation. The turn record indicates the total number of activations each player is allowed in the turn, and this is usually fewer than the number of activation chits. Players alternate drawing chits and activating formations. For the Axis, formations are divisions, although the *Pavia* and *Brescia* divisions activate together. For the Allies, formations are brigades. Once activated, each of a formation's units activates one at a time, conducting movement and combat in any order up to the limits of its movement allowance. Then it is flipped to its "activated" side, which shows half strength and no movement allowance. When the player has finished activating all of the units of the formation that he chooses, the other player makes a chit draw. When both sides have reached their activation limits, the turn is over.

Axis formation chits are two-sided, giving that player a choice of which formation to activate. The two *panzer* divisions, *15th* and *21st*, share chits. The Italian *Ariete* armored division and *Trieste* motorized infantry division share one, as do the German *90th Light* and Italian *Pavia-Brescia*. On some turns, more than one of the same activation chit is available, and so the Axis player could use both sides, or the same side more than once.

The Allies have single-use activation chits. What's worse, several of their infantry brigades have no chits at all. They do have one Double Move chit, which allows them to activate any two units, from any formations. Allied formations never have more than one chit in the cup.

Both players have the option of not activating the indicated formation but instead activating a single unit of any formation. This comes in handy more often than you might think. Also, one of the tactical chits (discussed below) is Extra Move, which allows activating an additional unit besides the ones in the current formation.

The tactical chits are also put into the cup with the activation chits. When drawn, the player may set them aside to use when he pleases, although a few have to be used right away. The tactical chits include:

- Extra Move (both sides): as described above.

Gazala: The Cauldron

- Combat (both): Provides favorable die roll modifier in one combat (attack or defense).
- Armor Replacement (both): Allows replacement of one lost step of an armor unit.
- Sandstorm (both): Reduces movement allowance by 2/3 for the current activation. Must be played when drawn.
- Airstrike (both): Attack any unit on the map. Allies have a small chance of disrupting the unit. Axis may disrupt or cause a step loss. Must be played when drawn. Negated if Sandstorm is drawn before it in the current activation.
- Antitank: (Axis only): Automatically causes step loss to Allied armor unit when played, in addition to any other combat result (attack or defense).
- Withdraw / Attack (Allied): Allied player must conduct one attack or withdraw a formation from the game (the latter is sometimes a good idea). If the Allied player draws this chit but fails to use it by the end of the turn, the Axis gets one victory point.

The map shows just the southern part of the battlefield, where the main action took place. Notably, Tobruk is not on the map; it is just to the north of where the map ends. Thus, this game has a somewhat constricted area compared with some other games on the battle, and it omits units, such as the two South African divisions, that spent the battle further north.

Units are battalion sized, although the Italian foot infantry are regiments (*Pavia* and *Brescia*). Stacking is two units per hex, except for those regiments, which may not stack. They are rated for anti-armor and anti-infantry strengths, plus movement. Units may be tracked, motorized, or foot. As noted above, the counters are double-sided, showing their strengths before and after activation. Infantry and antitank units are single-step. German armor has three steps, while Italian and British have two. Because the sides are used to track activation, steps reduction uses substitute counters.

Combat may be light, medium, or heavy, with increasing movement point costs to the active unit. Light attacks suffer a DRM penalty, while heavy attacks get a DRM bonus. When an active unit initiates combat, it must attack all enemy units to which it is adjacent. Friendly units adjacent to those units may participate. Participation does not cause them to flip to their inactive sides. Infantry units may not attack armor, even as supporting units. Antitank units (only the Axis has them) may not attack infantry; nor may they attack armor as the active unit (but they may participate if a friendly armor unit is active). If the enemy units include any armor, friendly units use their anti-tank strength (on attack or defense). Otherwise, they use their anti-infantry strength. Combat is odds based, using a D10 and a lot of DRMs. The CRT has a 3:2 column, but no 4:1 (maximum is 7:1). Combat results are step loss, retreat, or disruption. A disrupted unit has no ZoC, loses a third of its movement allowance, and is subject to an unfavorable die roll modifier in combat. Units are automatically undisrupted at the end of the turn.

The Gazala battle featured extensive Allied minefields and fortified boxes. Axis units may not cross minefield hex sides unless breached. Allied units pay a stiff movement penalty for doing so. Both sides suffer a DRM when attacking through them. Axis units may not trace supply through them. In the minefield phase at the beginning of each turn, the Axis may place two breach markers on their “under construction” side, in any friendly-occupied hexes. The units in those hexes may not activate for the entire turn. At the beginning of the next turn, if there is no Allied unit adjacent to the minefield hexside, the minefield is breached, and the marker is flipped over to indicate this. In addition, if there is no Allied unit adjacent to the hexside on the opposite

Gazala: The Cauldron

side of the hex, a lane is driven right through, breaching that side as well, and the marker is positioned to show this. If the minefield is not breached, the marker is removed, although it may be reused. The number of minefield breaches is limited by the supply of markers.

The Axis player gets victory points by eliminating Allied steps (1 each) and occupying fortified boxes at the end of the game. They also get points for each turn that at least four units are in hexes on the northern map edge and for each turn a unit occupies El Adem. They lose 2 points for every friendly step eliminated. If they have a positive VP total at the end of the game, they win.

May 27 AM

The Axis has an action limit of 4, to the Allied 2. The Axis wins the initiative die roll.

The Axis draws Extra Move, Armor Replacement, and then *Ariete*. Conveniently, the whole division is positioned to launch heavy or medium attacks against 3rd Indian. *132/10 Armor* starts the ball rolling, aided by three other units. 18 KEO Cavalry (all of these Indian units are infantry) is blown away, and *132/10* plus 5 *Bersaglieri* advance into the hex. Next, *132/9 Armor* tries to do the same to 2 PAVO Cavalry but merely disrupts it. However, a follow-up attack by *12 Bersaglieri* completes the job, and the two units occupy the hex. Then *44 Bersaglieri* moves into the hills and attacks 2 Royal Lancers. Surprisingly, this results in mutual step losses. The remaining unactivated units of the division move through the battle zone and take up positions to block the road from any advance by 4th Armour.

Gazala: The Cauldron

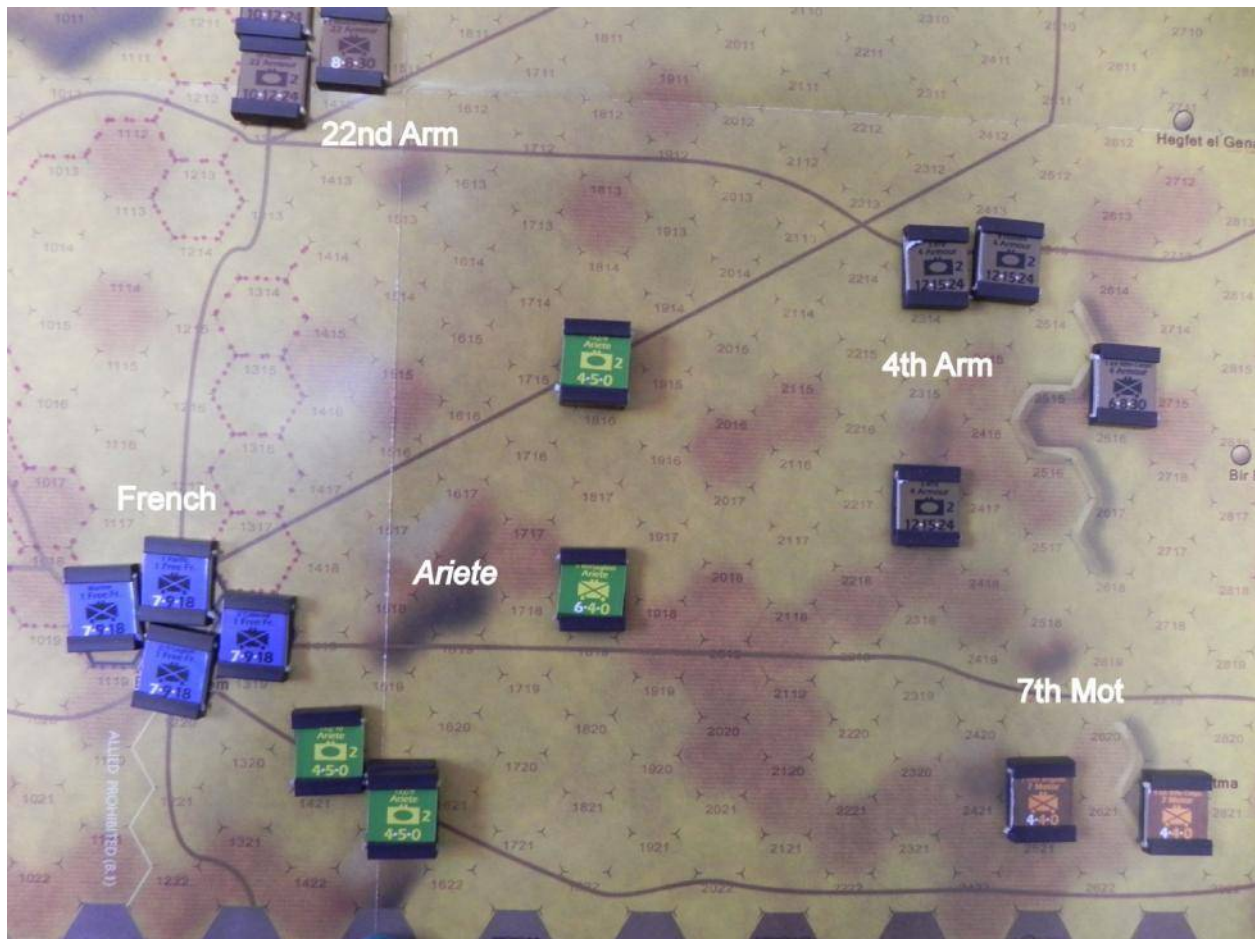

Ariete activation

Under the special first-turn rules, the Axis draws again. They get *Combat* and then *90th Light*. They throw a screen around Bir Hacheim to keep the French from causing trouble and send some units into the desert to link up with *Ariete*.

Gazala: The Cauldron

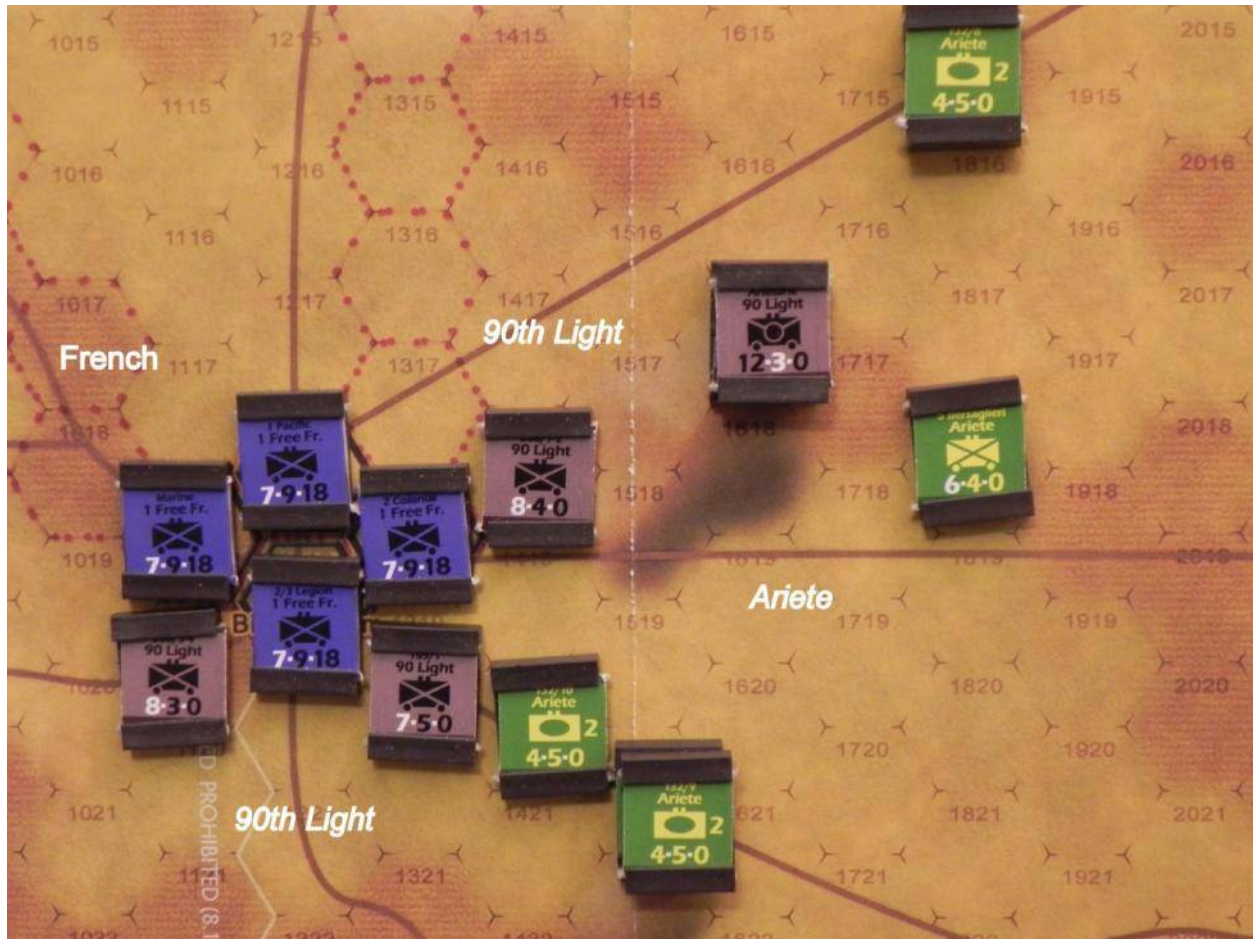

90th Light activation

The Allies draw Air Strike, which they use against 5 *Bersaglieri*. It has no effect. Then they draw 4th Armoured. The brigade concentrates all of its armour against 5 *Bersaglieri*. It's a 5:1 attack, but the Italians are on a hill, and the Axis commits its Combat chit. The Allies roll a "0," and the result is that two tank units are disrupted. The brigade moves its infantry to help protect one of the disrupted units.

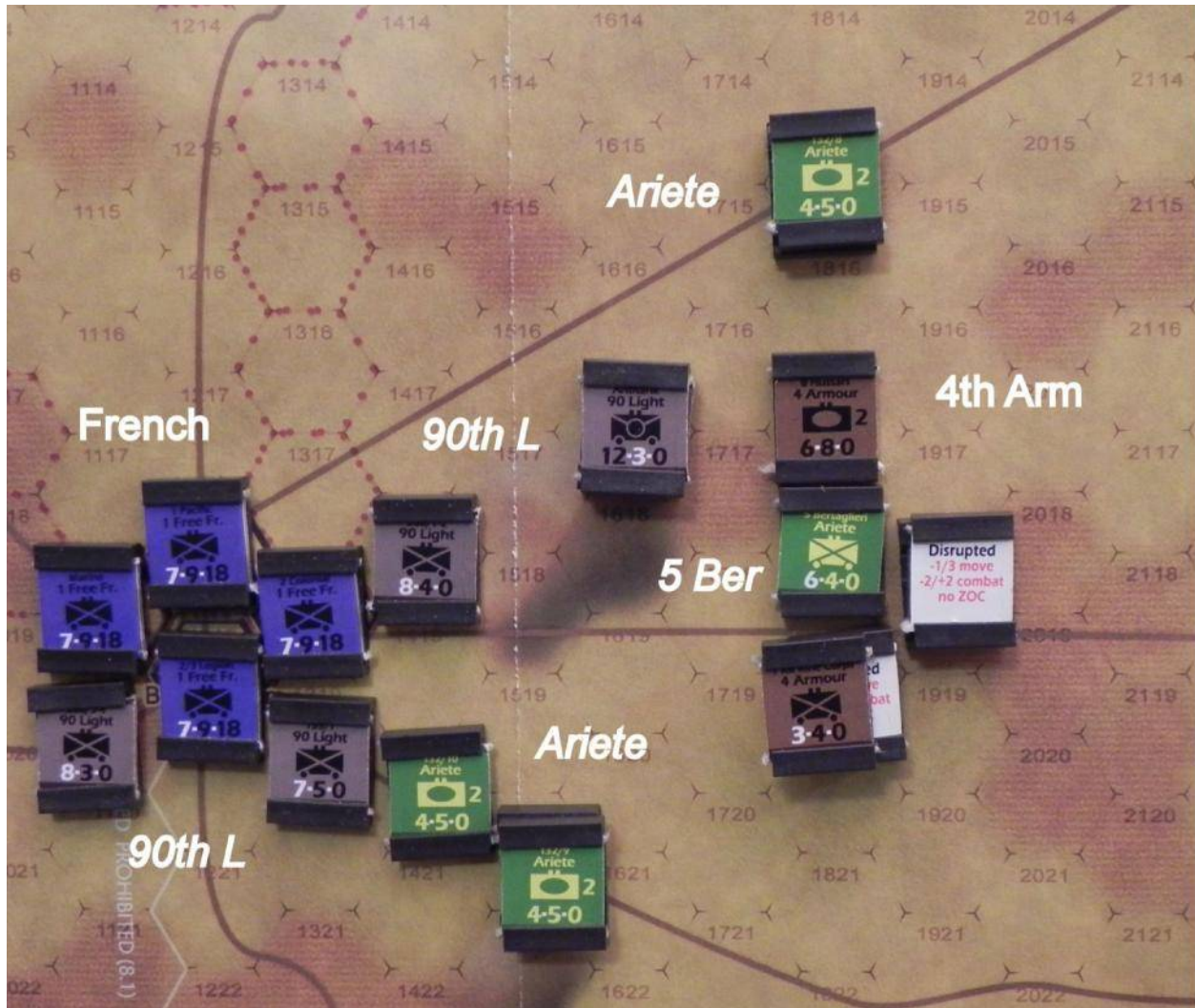

4th Armour activation

The Axis gets its Air Strike, which it uses against the (not disrupted) 8th Hussars, to no effect. Then they draw a 15/21 Panzer chit and choose to bring in 15th Panzer. The division first throws a ring of infantry and motorcycle troops around the entire 4th Armoured. Then 8/2 Panzer, supported by their antitank unit and 5 Bersaglieri, attack 1 KR Rifles and the disrupted 3 RTR. The result is that 3 RTR loses a step. Then 8/2 Panzer attacks the same stack again, aided by all the units from the first attack. This disrupts 1 KR Rifles. The activation ends with all of 4th Armour surrounded and three of its four battalions disrupted.

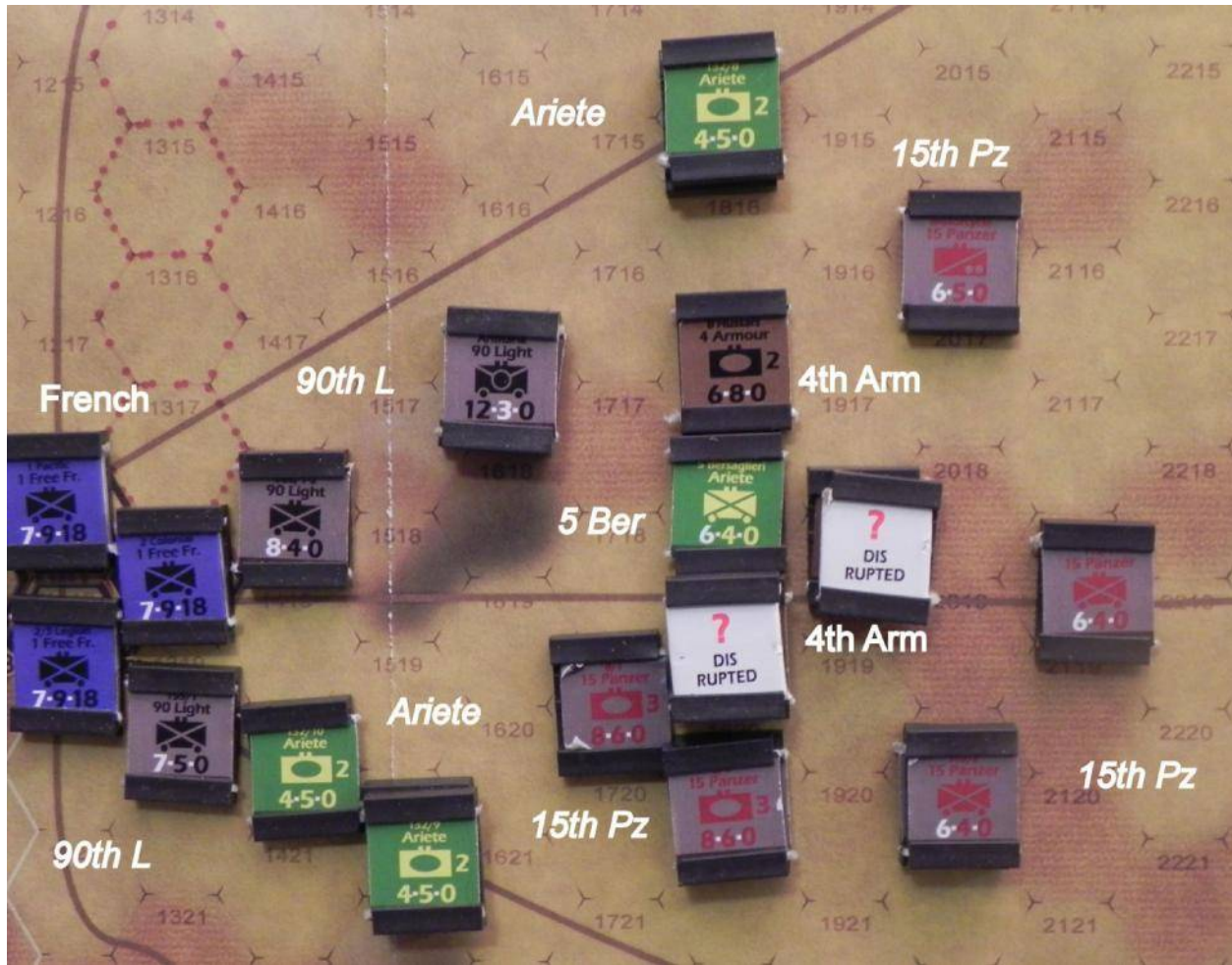

15th Panzer Activation

The British draw Combat, Withdraw/Attack, Armor Replacement, and then 7th Motorized. The Withdraw/Attack chit requires the British to remove a formation from the map, make at least one attack, or give the Germans a victory point. The Armor Replacement chit can't be used, because the armor unit to which it might apply is in an enemy ZoC and surrounded. 7th Motorized surrounds *115/1* and attacks it at 3:1 odds, trying to open up a supply line to 4th Armour. The Germans are rough terrain, but the British use their Combat chit. *115/1* has to retreat. It is disrupted by retreating through the British ZoC in the first hex.

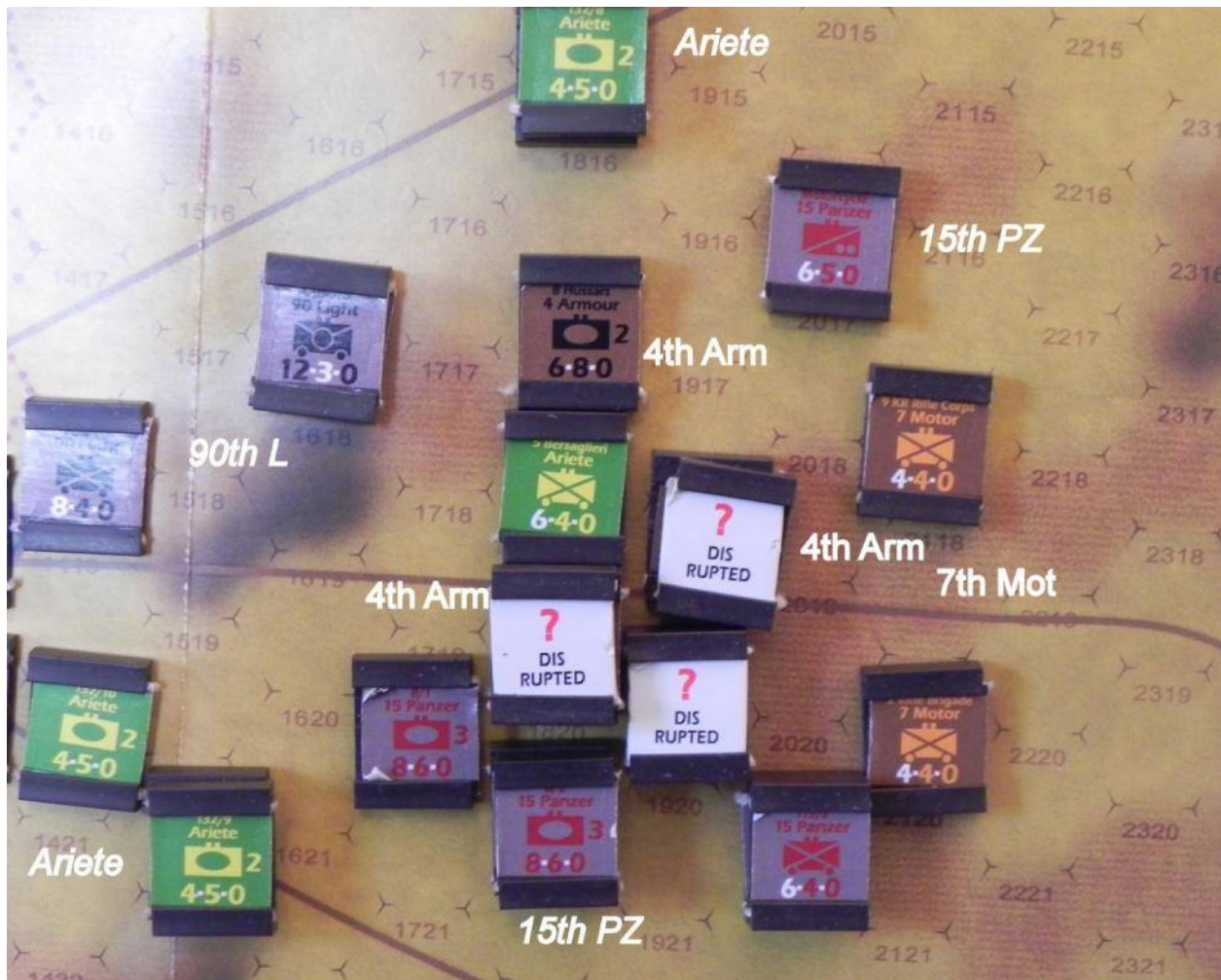

7th Motorized adjacent

The Germans activate *21st Panzer*. They use their Extra Move to activate *115/2* to surround 7th Motorized, adding it to the bag they had been trying to cut open. *5/2 Panzer*, supported by the division's antitank unit and *5 Bersaglieri*, attack 8th Hussars, getting a retreat/disrupt result. Because the retreat route would take the disrupted unit through two enemy ZoCs, it runs out of steps and is eliminated. *5/1 Panzer* then renews the attack on 3 RTR and 1 KR Rifles, supported by elements of *15th Panzer* and (yet again) *5 Bersaglieri*. That finishes off the British units for good. *21st Panzer's* infantry then surges northward, taking up positions to block any counterattack from 22nd Armour next turn.

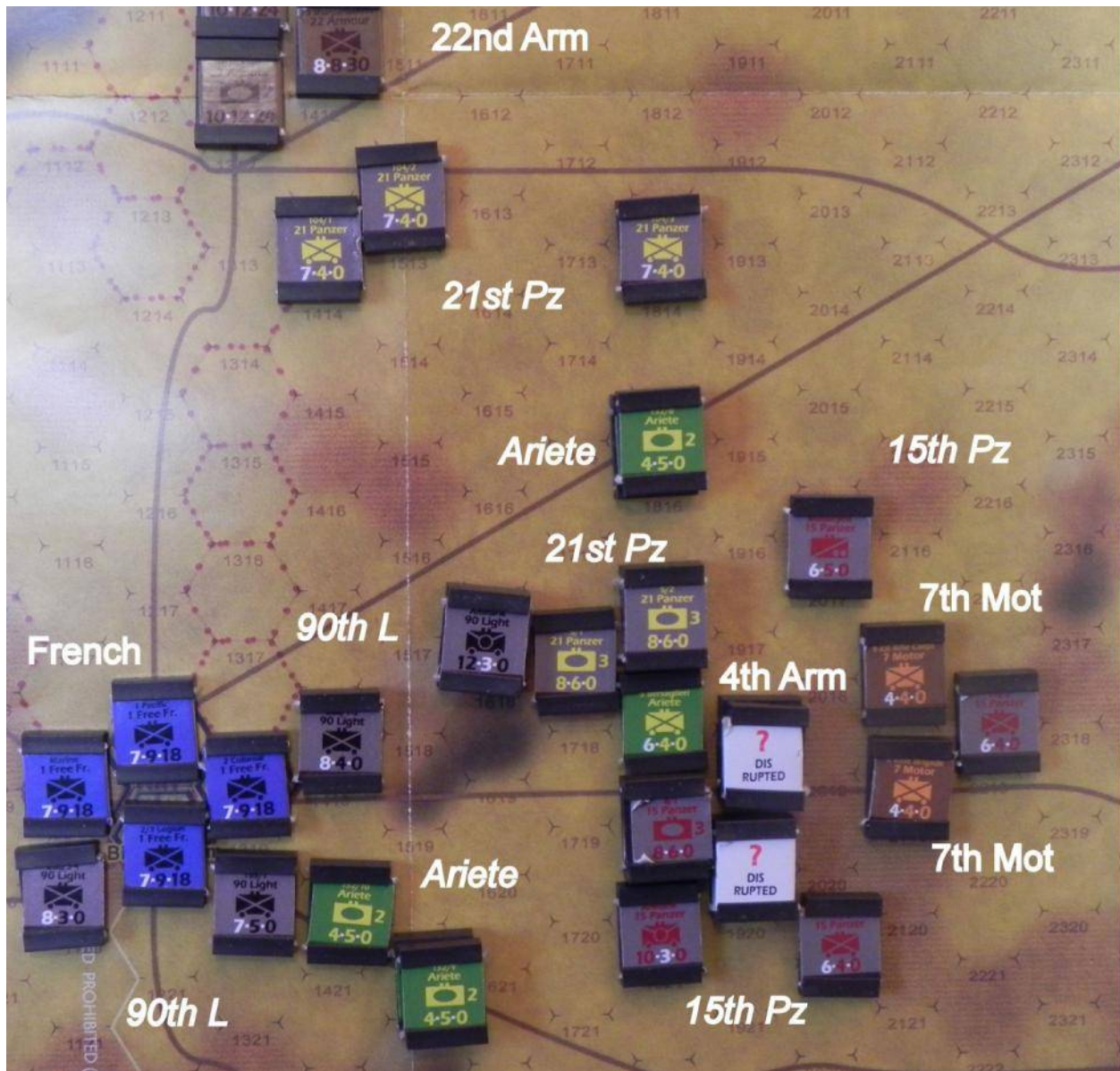

21st Panzer

May 27 PM

The Allies have 5 activations this turn, while the Axis has 4. The one remaining unit of 4th Armour and the two 7th Motorized units are out of supply. The Germans have the initiative.

The Germans draw 15th/21st Panzer. Striving to keep the British off balance, they activate 21st Panzer. They mount an attack with armor and infantry against 3 Sharpshooter (the infantry of 22nd Armour), disrupting it. The 21st's other infantry unit and antitank unit deploy on the flanks to discourage encirclement.

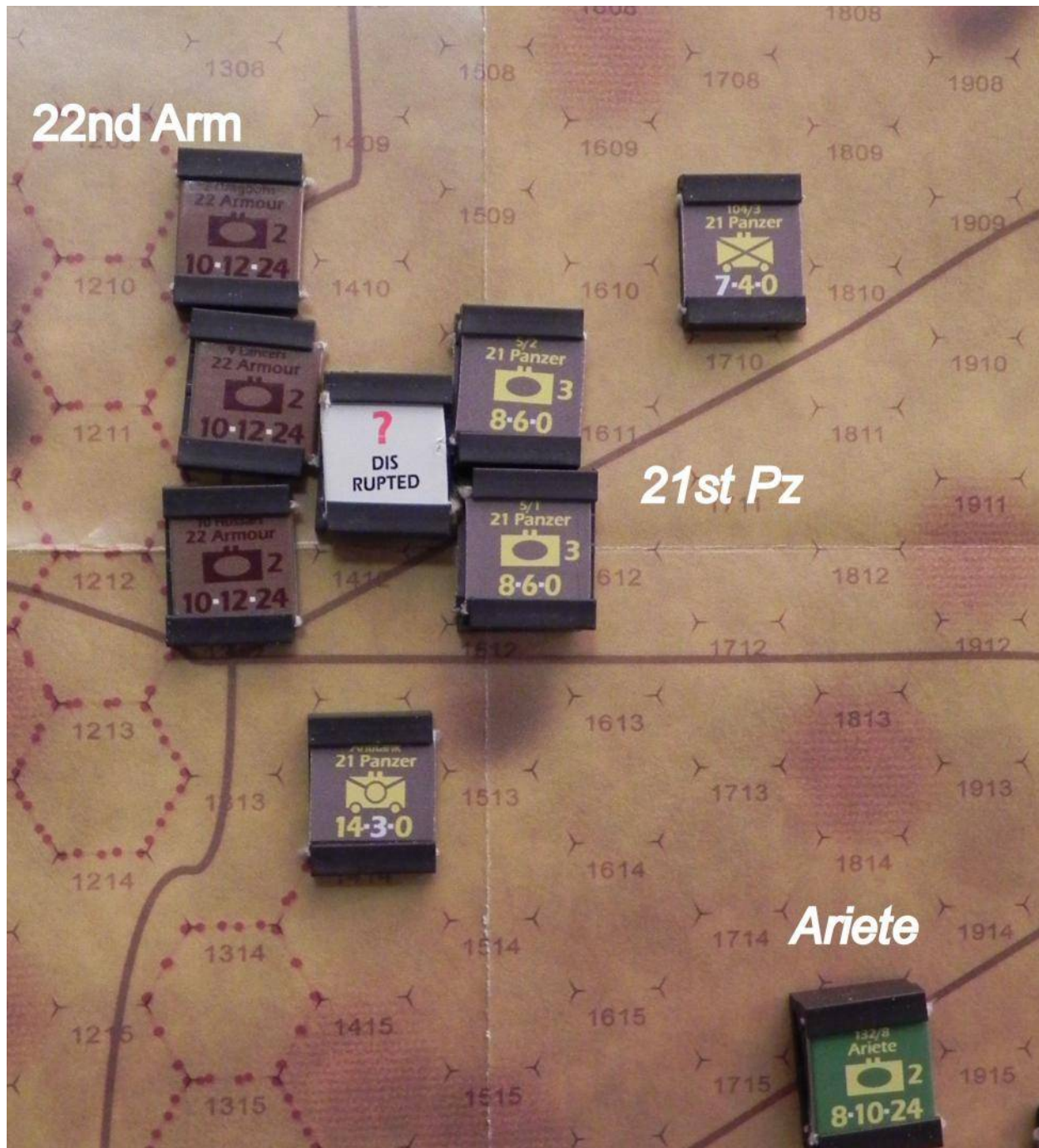

21st Panzer

The Allies draw their Air Strike. They use it against *115/2 Infantry*, since if that unit were disrupted the units in the pocket could extricate themselves. Unfortunately, the air strike has no effect. Then the Allies draw *Withdraw/Attack*, which they set aside, and then *1 Army Tank Brigade*. This is a unit consisting of three weak armour battalions (8, 42, and 4 RTR). They are positioned to be the reserve for the infantry watching over the minefields. While it's tempting to move them east and in the way of *21st Panzer*, it's early in the game to be weakening the barrier to the west. Instead, the Allies choose the option of activating one other unit, in this case *5RTR*,

which is the only unit remaining of 4th Armour. It moves to stack with one of the units of 7th Motorized, and all three units attack 115/2 in a breakout attempt. It's a pretty desperate attack. The odds are 2:1, but the combination of supply, light attack, and rough terrain result in a -5 DRM. However, the Allies roll high and get a mutual step loss, eliminating the German unit. 5RTR loses a step as well. The 7th Motorized units advance after combat while 5RTR uses its remaining movement point to move to the northeast. (This also satisfies the requirements of the Withdraw/Attack chit.)

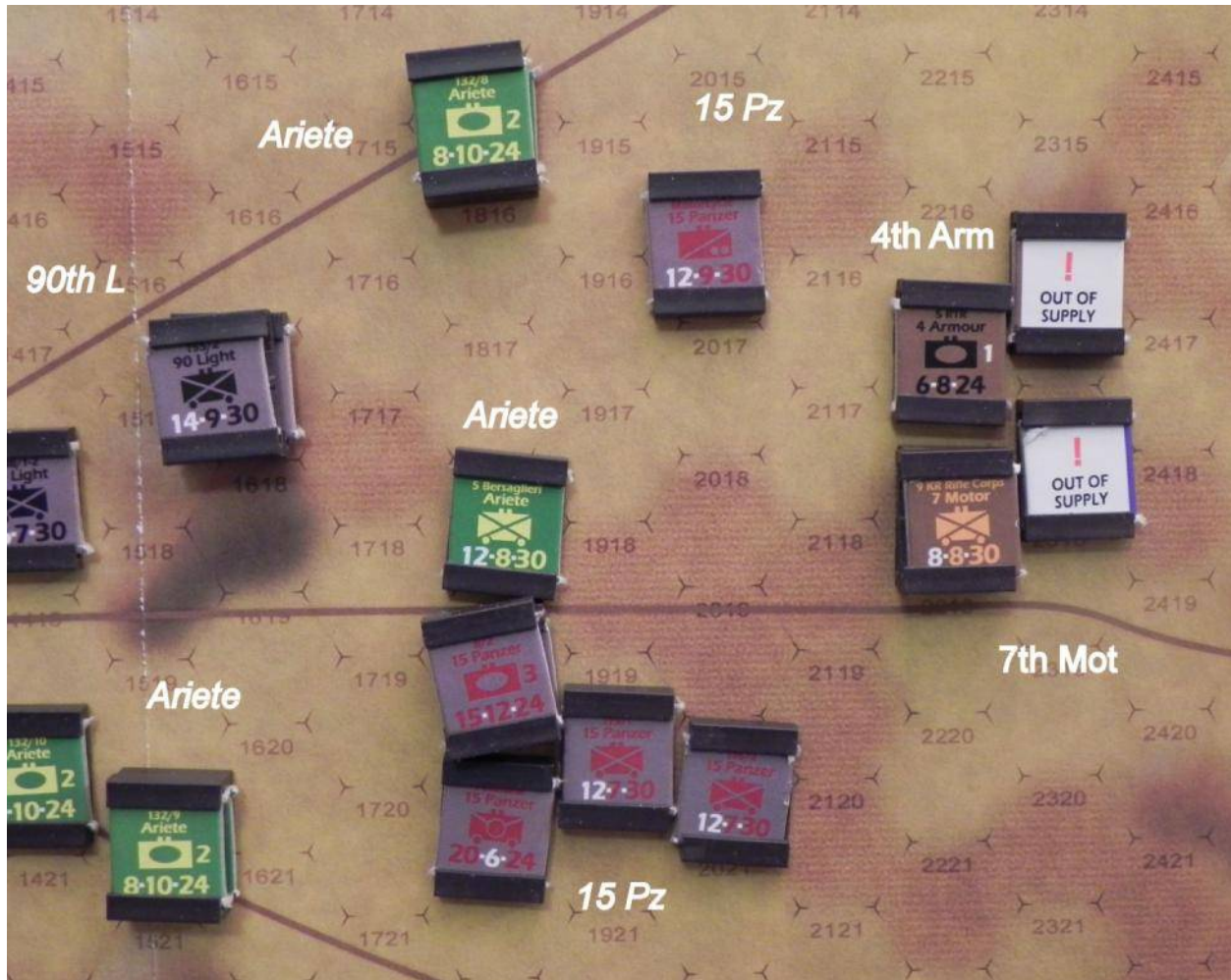

5RTR

The Axis get their airstrike, which they use against 5 Dragoons (22nd Armour), to no effect. They then draw *90th Light / Pavia-Brescia*. The former is deployed keeping the French in their fortress. *Pavia* is not allowed to move this turn, by special rules, and *Brescia* isn't on the map yet. So the Axis choose to activate *5/2 Panzer*, enabling it and most of the rest of *21st Panzer* to attack the now-disrupted 3 Sharpshooter. They could launch a heavy attack, but they choose to keep it to a medium, so that *5/2 Panzer* can maneuver afterwards. It's a 3:1 attack, with +2 for the disruption but -1 for rough terrain. The result is a disappointment: disruption, which is ignored for an already-disrupted unit. *5/2 Panzer* moves to the northwest in order to pin 22 Armour between the Germans and the minefield behind them.

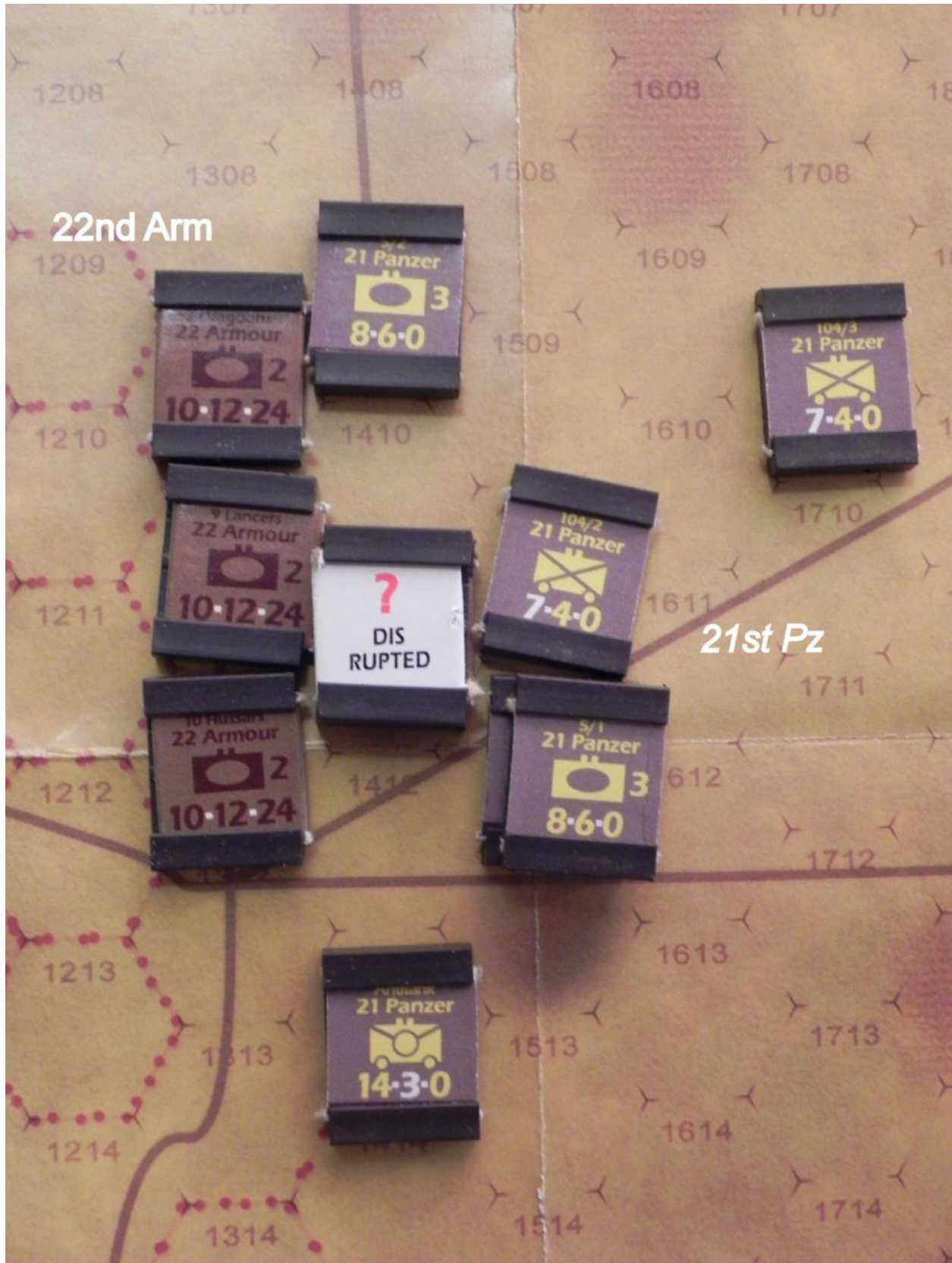

5/2 Panzer

Gazala: The Cauldron

The Allies draw 4th Armoured. Its single, understrength, remaining unit scampers all the way back to the El Adem Box, where it has some hope of surviving until it can rebuild.

The Axis draws *15th/21st Panzer* and decide to activate *15th* this time. Tempting though it is to finish off 7th Motorized, the Germans decide to get moving toward the victory points at the northern edge of the board while they can. The entire division streams north. The infantry occupies the hills southeast of the Knightsbridge Box. The two panzer battalions reach Bir Lefe, on the edge of the escarpment. The recon unit is sent to keep an eye on the units in El Adem, and the antitank unit is in reserve.

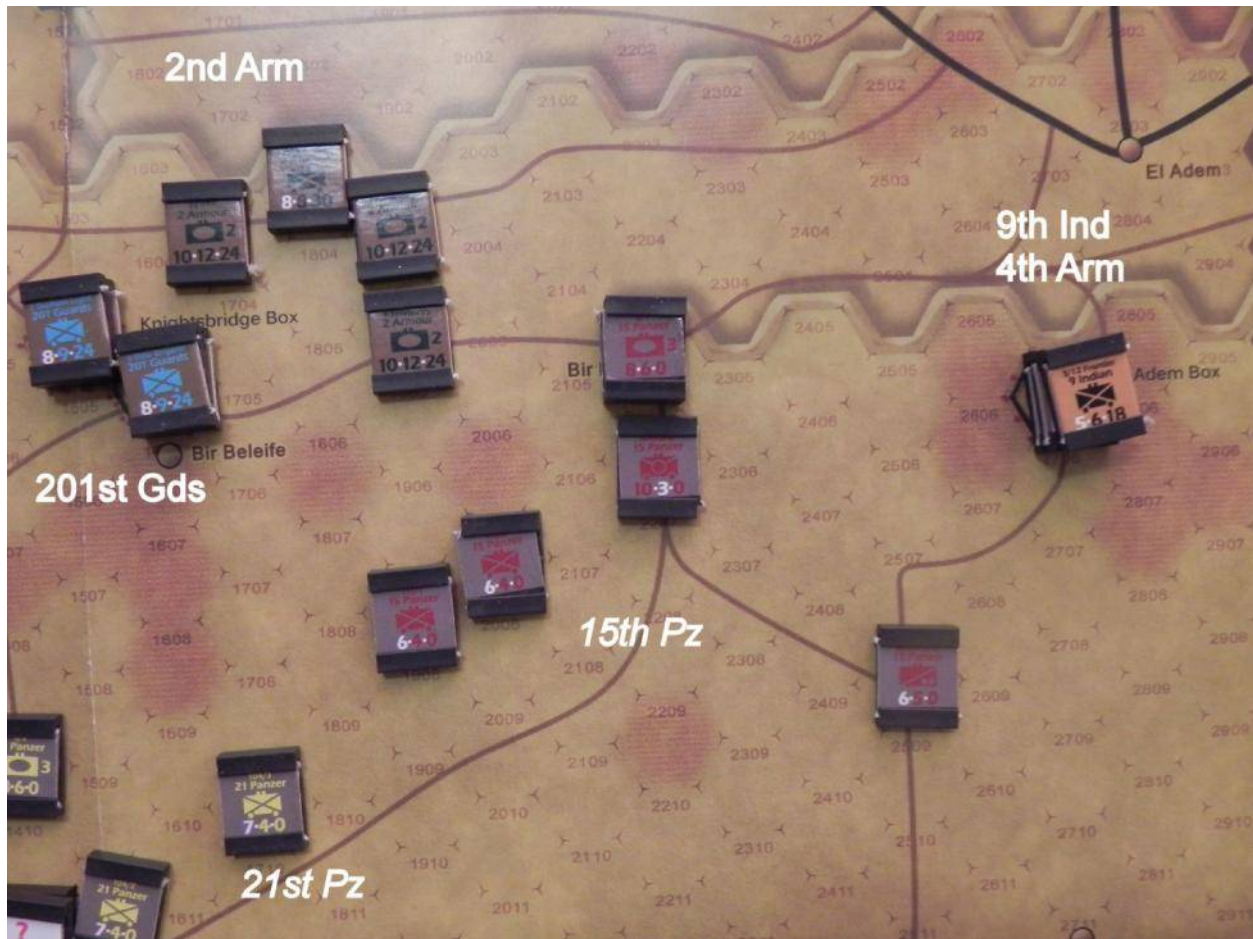

15th Panzer

The Allies draw Armour Replacement and then 22nd Armour. They can't use the replacement to rebuild 5 RTR, because it is out of supply. They could use it to replace another 4th Armour unit at half strength, but that can wait until their last activation, if nothing more important turns up.

22nd Armour launches a heavy attack against *5/2 Panzer* with 9 Lancers and 2 Dragoons. The odds are only 3:2, but the heavy attack is a +2 on the die. The result is a mutual step loss. The British take theirs from the Dragoons. 5 Sharpshooters, disrupted, pulls back into the relative safety of the minefields. 10 Hussars then renews the attack against *5/2 Panzer* with the support of the other two tank units, although it now must also engage *104/2 Infantry*. The result is

Gazala: The Cauldron

another mutual step loss. The Germans reduce 5/2 *Panzer* again, rather than lose an irreplaceable infantry unit.

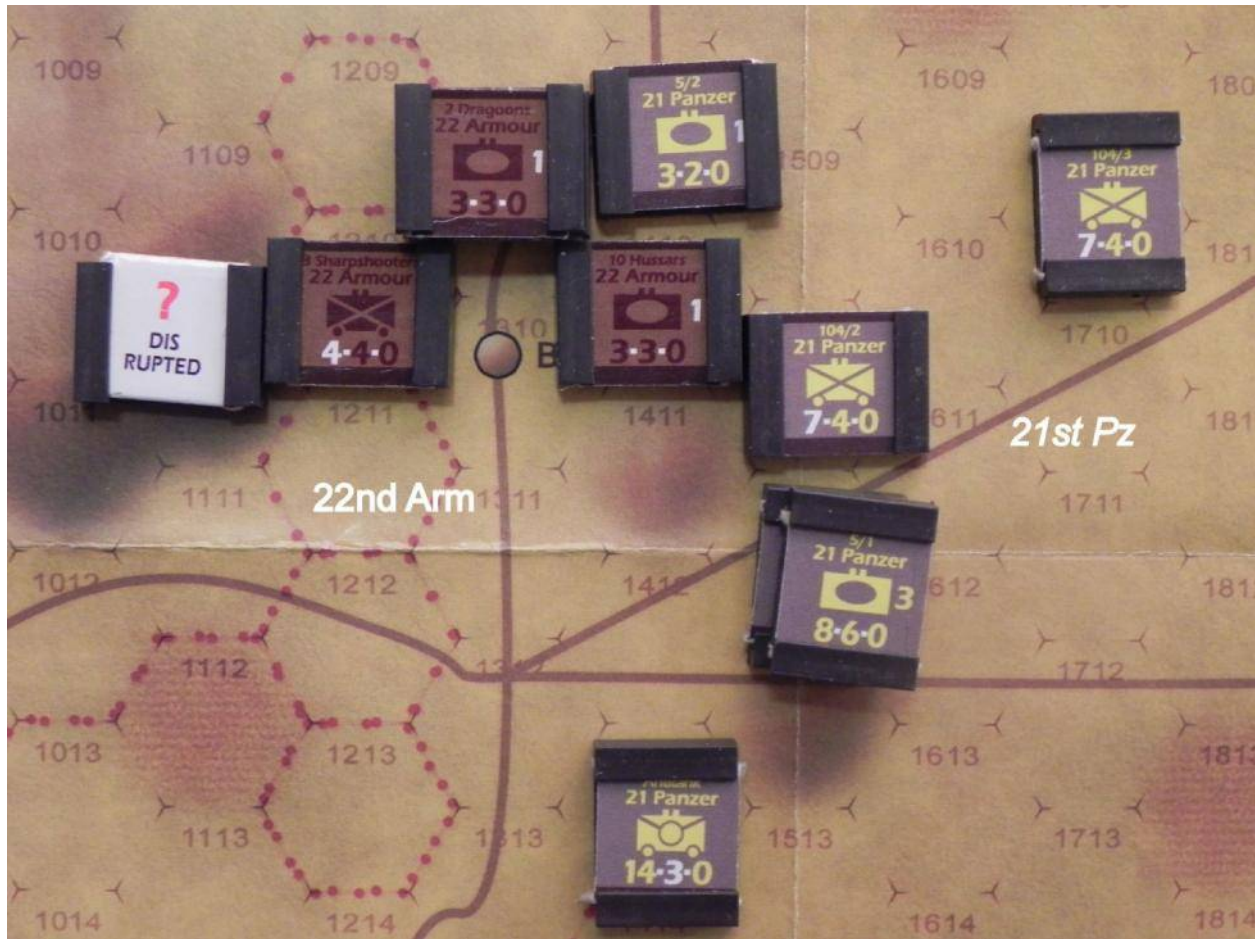

22nd Armour

The Axis draws Anti-Tank, which probably won't do them any good this late in the turn, and *Ariete/Trieste*. They activate *Ariete*, which sends everything it has against 7th Motorized. Even at that, the odds are only 3:2, but they have a +2 for out of supply, and they get /R* (retreat with step loss) result. 7 KR Rifle is eliminated, and 2 Rifle has to retreat through the Italian ZoCs, disrupting it. Because *Ariete's* antitank unit is useless in combat against infantry, it is sent to join *15th Panzer's* recon unit near the El Adem Box.



Ariete

The Allies draw Combat, Extra Move, Sandstorm, and then 7th Motorized. The effect of Sandstorm is to reduce movement by 2/3 for this activation. That means that 2nd Rifle, already out of supply and disrupted, is totally immobilized. However, 7th Motorized does have another battalion, 2 KR Rifle, waiting as reinforcement. It enters the map and moves to block the road off the escarpment near El Adem.

The Axis has no more actions left, but the allies have one. They draw 2nd Armour. First they use the Armour Replacement chit to replace 4th Armour's 3 RTR at reduced strength, placing it on the road near El Adem. Then they use Extra Move to activate 9 Lancers (the one full-strength tank unit in 22nd Armour) which renews the attack on 5/2 Panzer, supported by its understrength associates. The odds are 8:1 (which is 7:1 on the CRT), with +2 for a heavy attack. The results are very bad for the British. Axis plays its Anti-Tank chit, which reduces 9 Lancers. The Allies roll a 1, resulting in a /D result. Disrupting 5/2 Panzer is meaningless in the last activation of the turn, as it will recover as soon as the turn ends.

2nd Armour moves 3 and 4 Yeomanry to attack 115/3 Infantry (15th Panzer), playing their combat chit. The odds are 3:1, on a hill, so the DRM is +1 -2 = -1. The result is mutual step loss, which eliminates the German unit and reduces 4 Yeomanry. The tank unit completes its activation by moving to a rough terrain hex just southeast of the Knightsbridge Box. 2nd Armour then moves its infantry and remaining tank unit to a hex northwest of the German position of Bir Lefe to prevent them from getting around the flank.

Gazala: The Cauldron

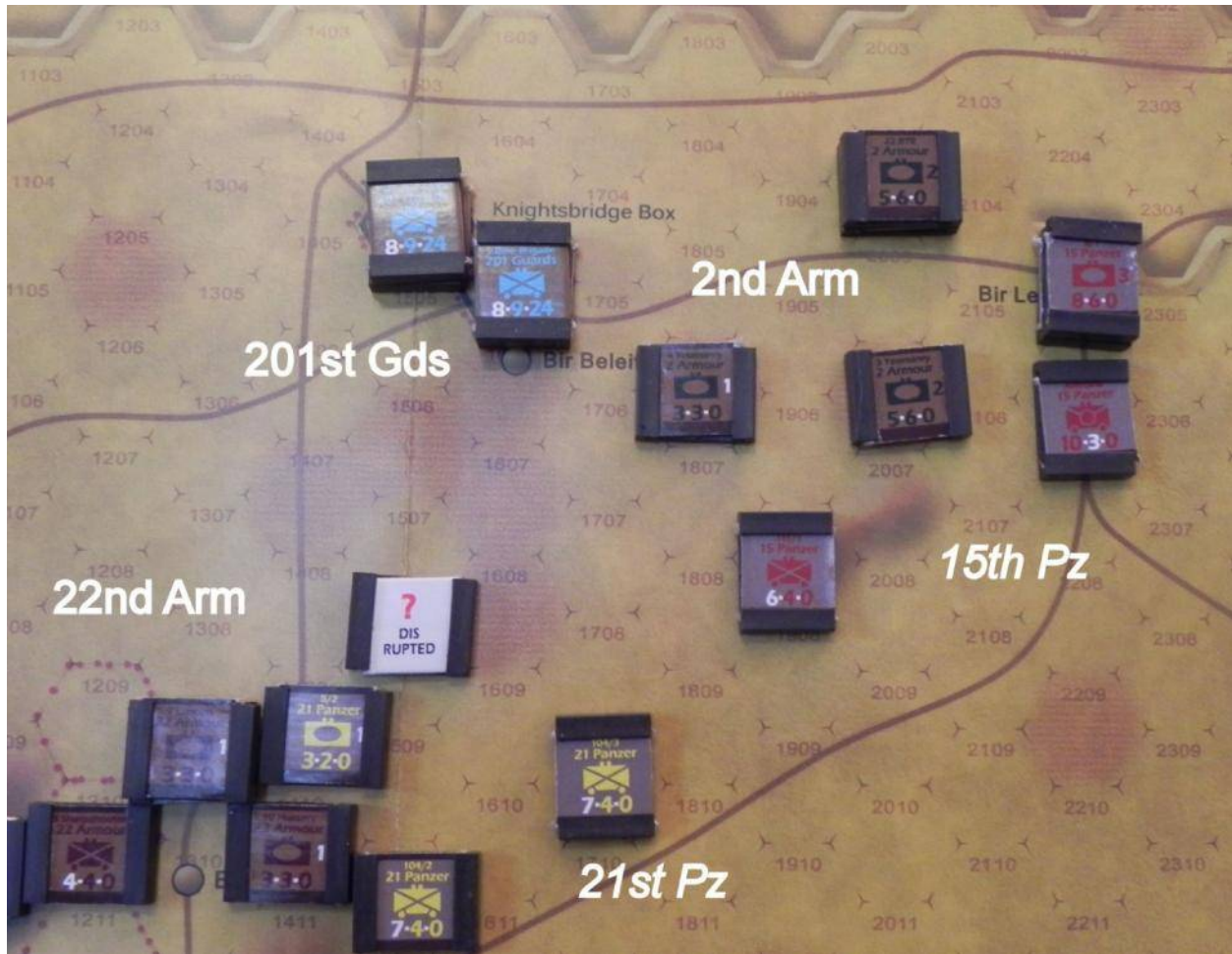

2nd Armour

May 28

The Allies get 5 activations, and the Axis gets 3. The special limits on certain units activating have been lifted. The Allied “Double Move” chit is added to their cup. The Axis activation chits are the same as the previous turn. No reinforcements are due.

Although victory points for eliminated steps don’t count until the end of the game, I’ve started tracking the points for lost infantry steps, since they can’t be replaced. On that basis, the Germans have 1 point, but that doesn’t take into consideration the armor losses on both sides (the Allies have lost more).

All units are in supply. All disruptions have been removed.

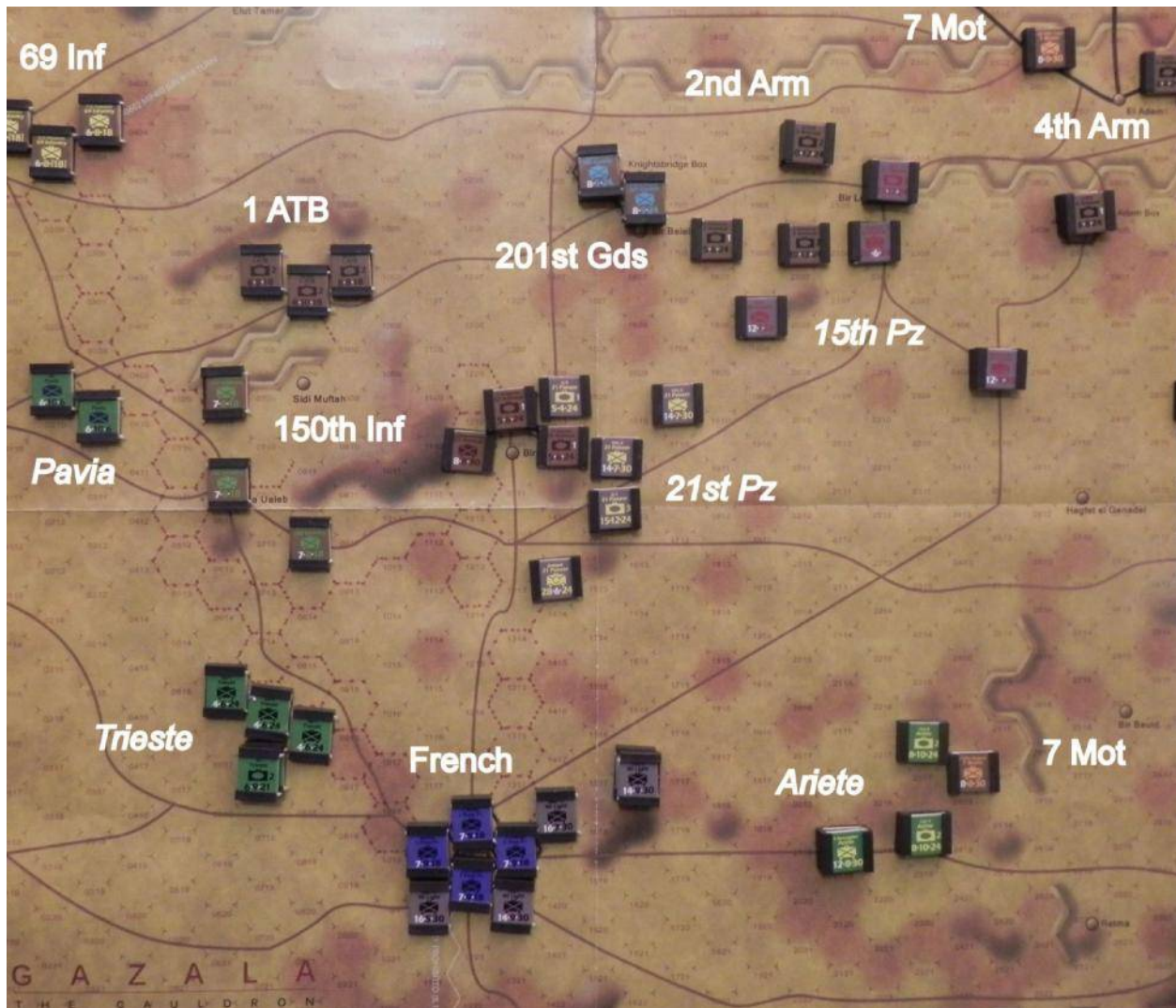

Start of May 28 Turn

The Axis places minefield breach attempt markers opposite hexes 0815 and 0915.

The Axis wins the initiative and decides to move first. They draw *15th / 21st Panzer* and decide to activate *21st*. First, they move their antitank unit up so that it can support *5/2 Panzer* in another attack on *10th Hussars*. It's 3:1 with a +2 for heavy attack. The result is /RD. The Hussars are disrupted, but fortunately they can retreat through some of their compatriots and avoid elimination. They wind up inside the minefields—not a bad place to be while disrupted. Next, *5/1 Panzer* moves to put the hurt on *9th Lancers* and *2 Dragoons*, supported by *5/2* and the antitank unit. They do quite well, eliminating the Lancers and forcing the Dragoons to retreat. Leaving one infantry unit (*104/1*) to watch the vital gap between the minefields at 1312, the division advances north towards the Knightsbridge Box.

Gazala: The Cauldron

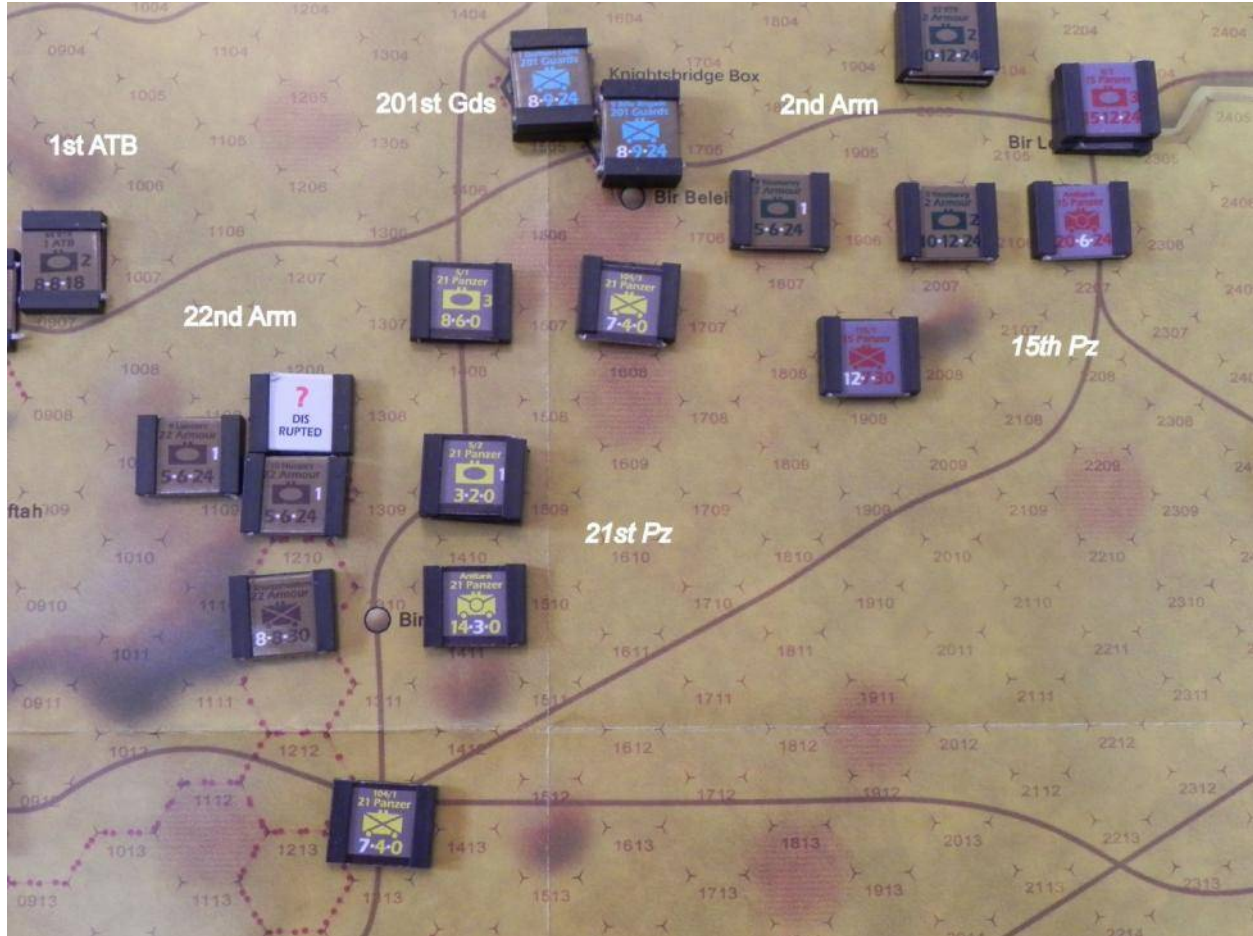

The Allies draw 4th Armour Since that formation is just two understrength tank units, they use the activation to pull the French 1 Pacific Infantry battalion out of Bir Haichem so that it can prevent one of the Italian mine-breaching attempts from breaking clean through.

The Axis draws *Ariete* / *Trieste*. With Trieste banging against the minefields, they activate *Ariete* to finish off 2nd Rifle Brigade (7th Motorized). That they succeed in doing, albeit at the cost of a tank step from 132/8. They also send an infantry battalion (5 *Bersaglieri*) to shore up 21st Panzer's position further north.

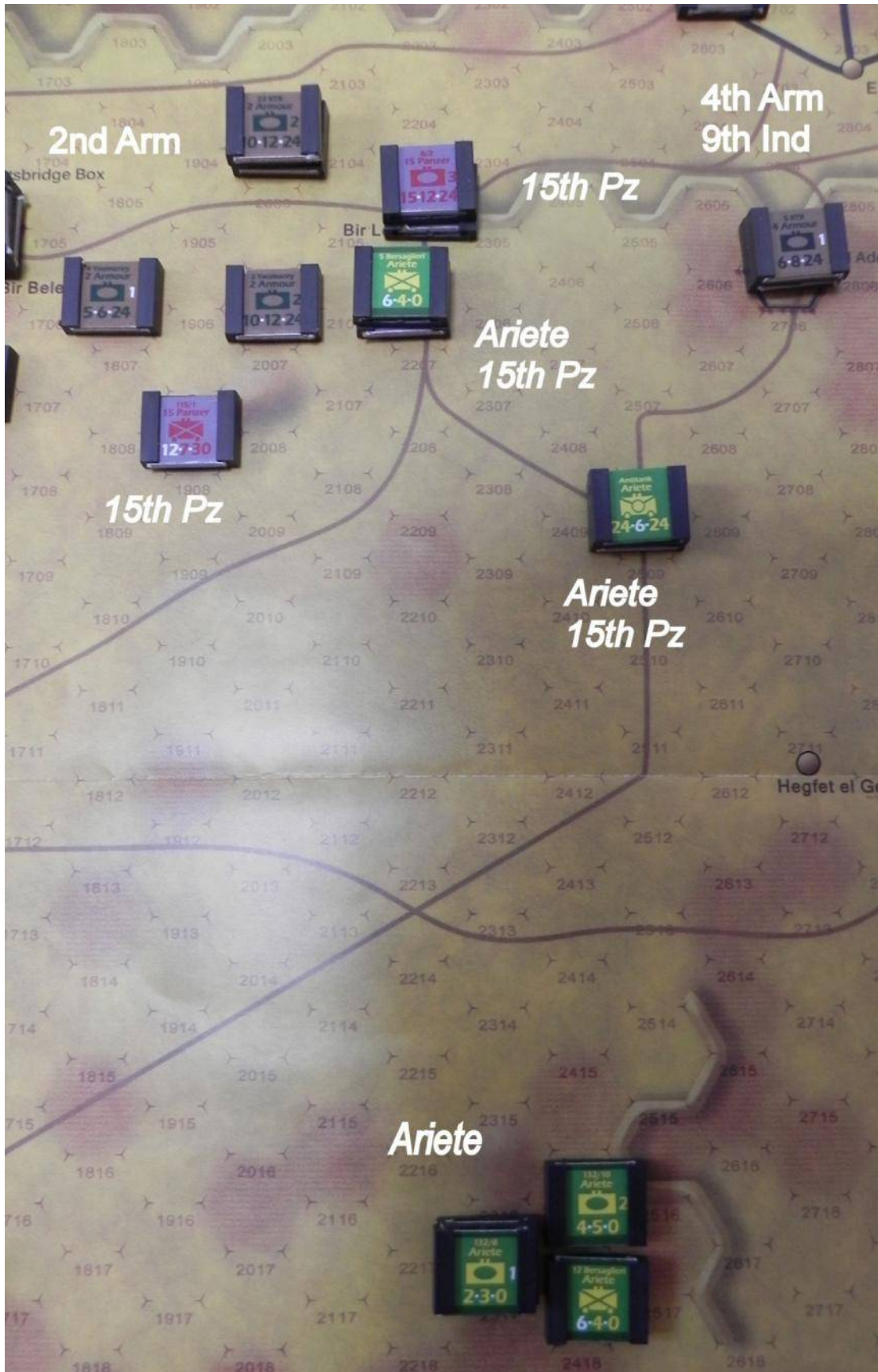

Ariete

The Allies draw Combat and then 2nd Armour. The tankers aren't strong enough to attack any of 15th Panzer's units while the Germans are on their unactivated sides. So the Allies decide to use the chit to activate 5th Green Howards, of 150th Infantry, who move down to join the French in holding the minefield against Trieste.

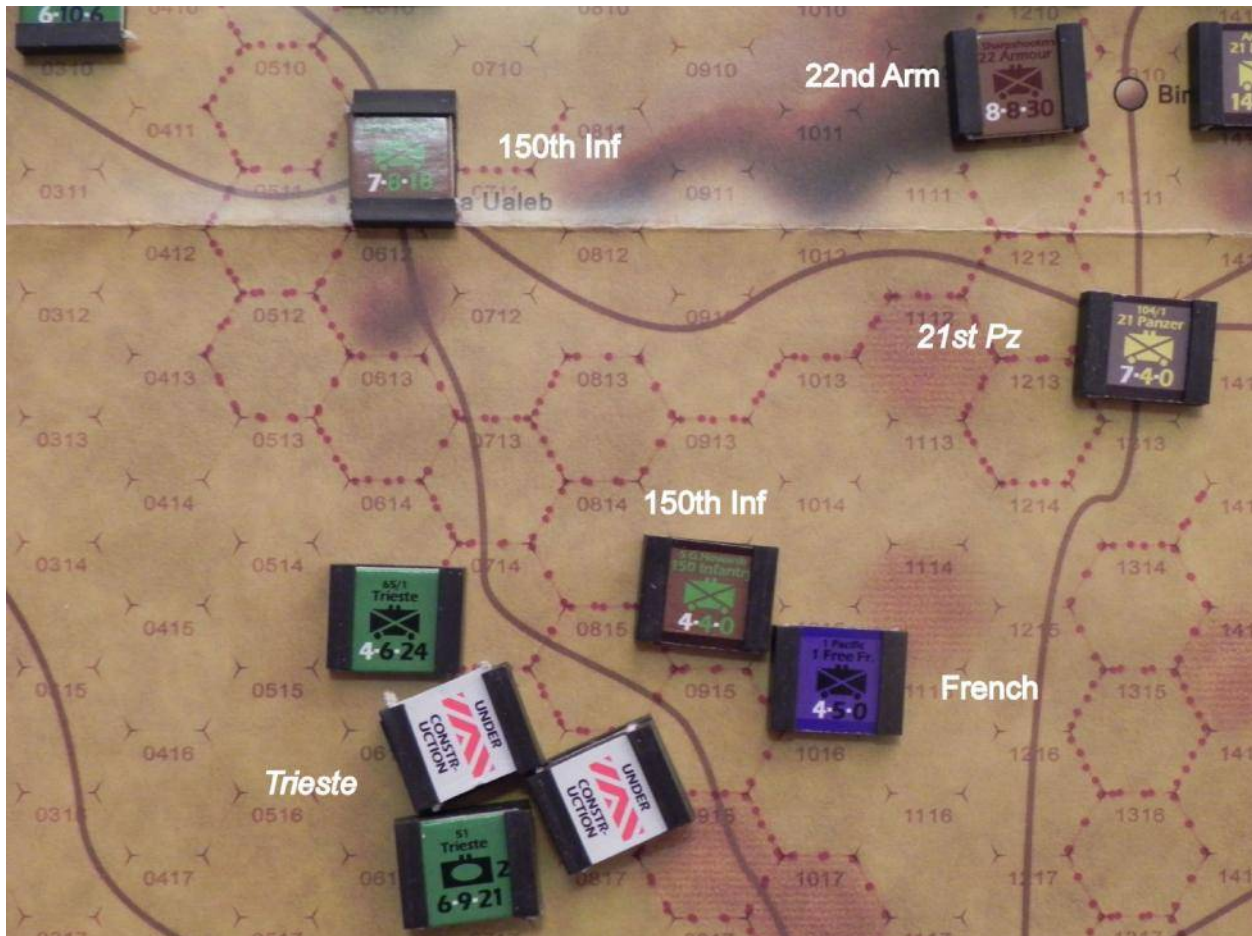

French & 150th Infantry

The Germans draw Combat, Extra Move, Anti-Tank, Sandstorm, and then 90th Light / Pavia-Brescia. In a sandstorm, the only kind of attack a unit would have the movement points to launch would be a light one, and then only if it were adjacent to the enemy to start with. The only unit like that is the 90th Light surrounding Bir Hacheim. However, launching a light attack into a fort through a minefield doesn't seem like a good idea. The Axis use the activation and the Extra Move to shuffle 15 Panzer's recon unit and Ariete's 5th Bersaglieri so that the former is reunited with its division and the latter joins its own antitank unit watching the El Adem Box. This is the last German activation for the turn.

Gazala: The Cauldron

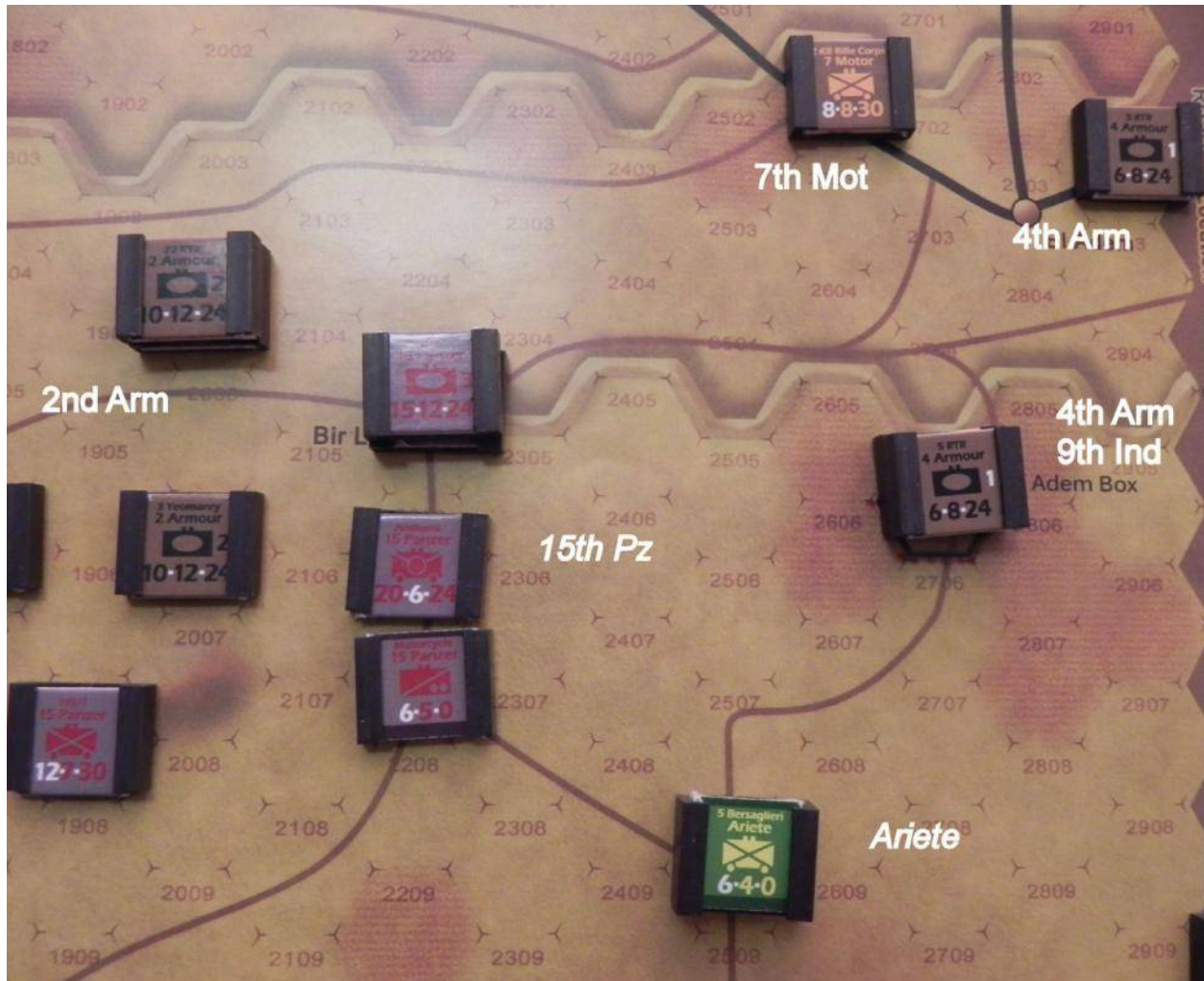

Germans shuffle around

The Allies draw 1st Army Tank Brigade. They move two battalions south where they can react to a breakthrough by *Trieste* and move the other to directly next to the minefields that *Pavia* might seek to breach.

Gazala: The Cauldron

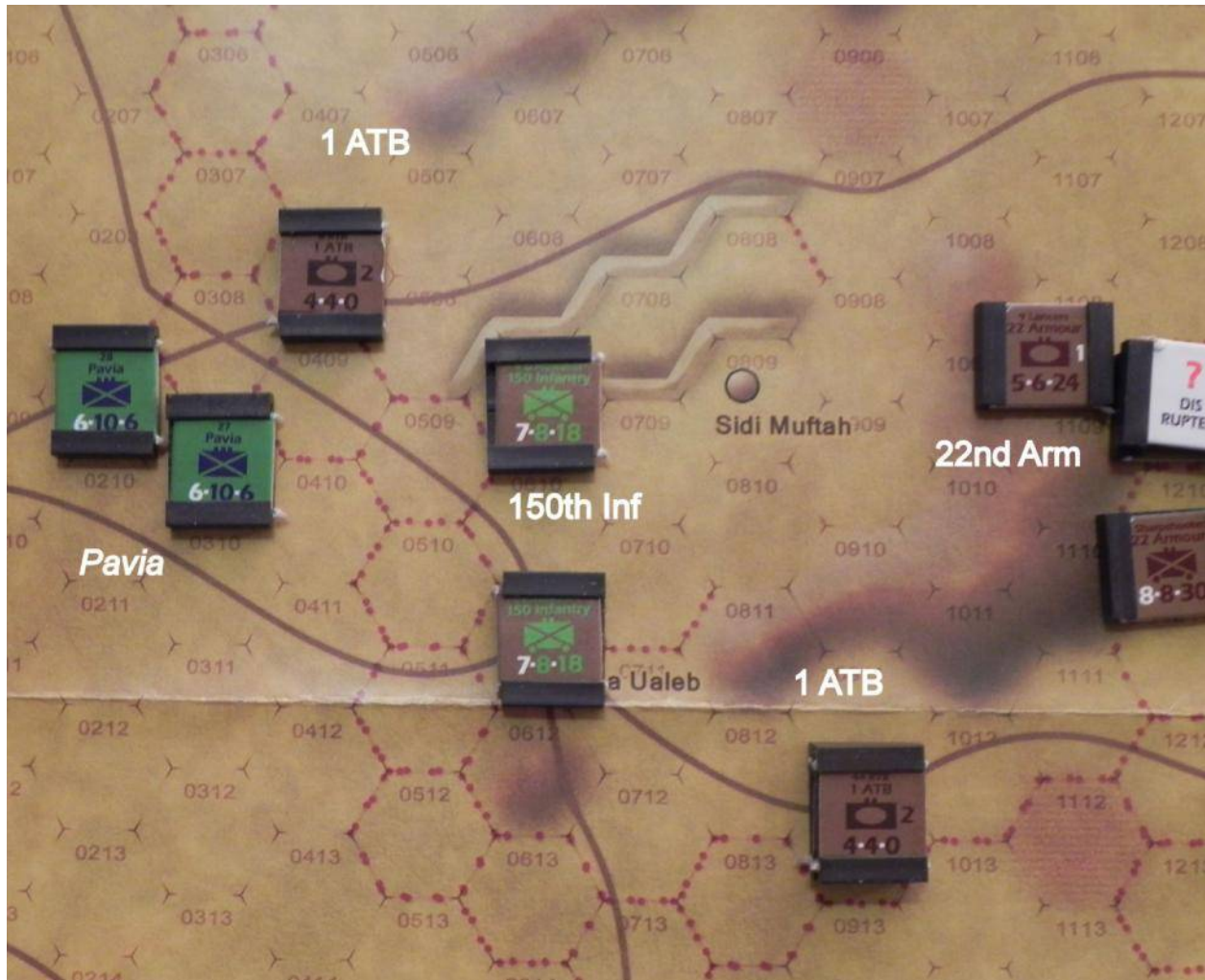

1st Army Tank Brigade

The Allies draw 22nd Armour. It is pretty battered at this point, with two understrength tank battalions (one of them disrupted) and its infantry. They pull back to defensible terrain west of the Knightsbridge Box, in order to impede *21st Panzer's* run to the north.

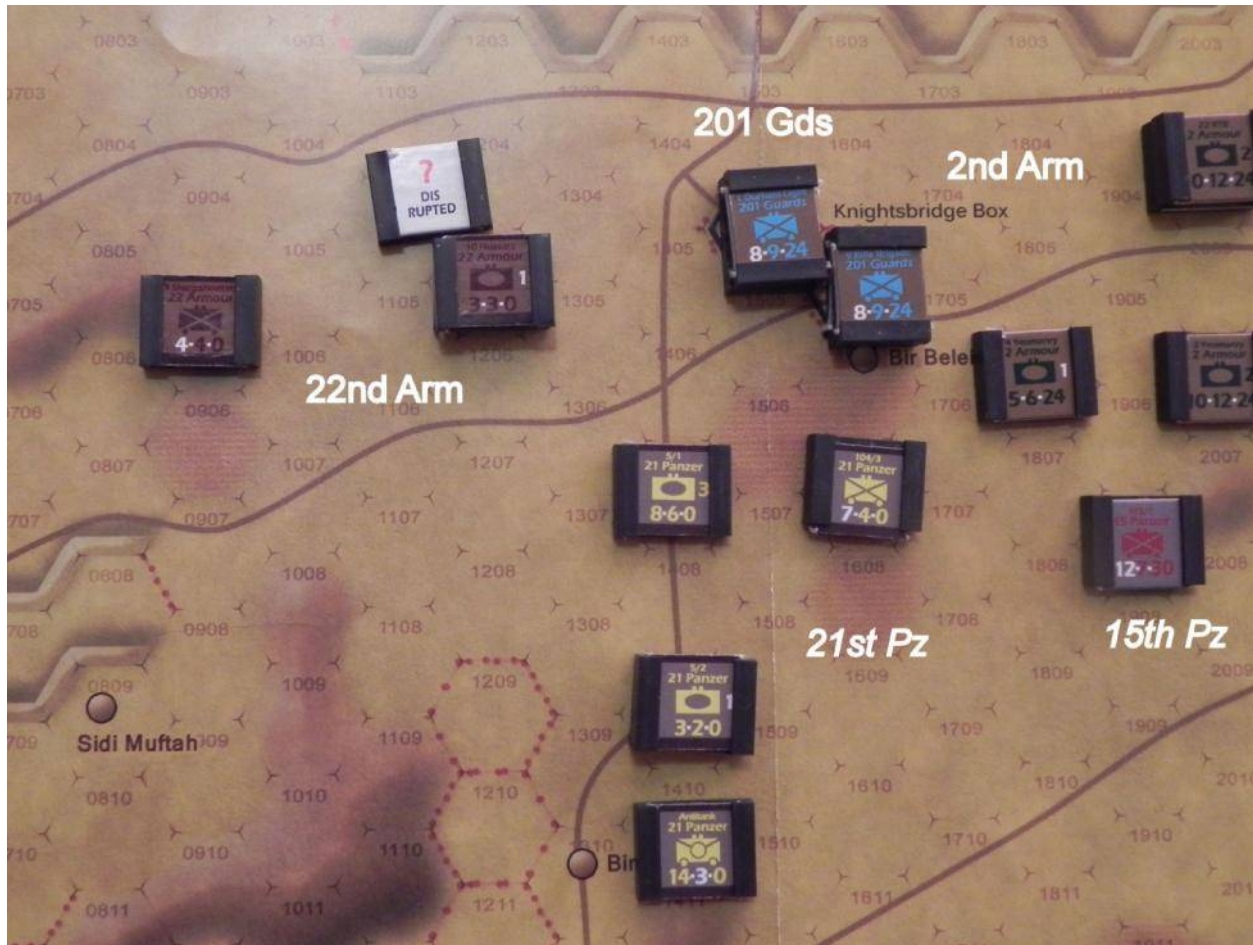

22nd Armour

The Allies have one more activation. They draw Withdraw/Attack, Airstrike, and 7th Motorized. They launch the air strike against 288/3-4 *Infantry*, of 90th *Light*, which is holding the perimeter around Bir Hacheim. The result is disruption. Instead of activating 7th Motorized (which is only one battalion), the Allies activate the French 2/3 Legion to launch an attack against the now-disrupted German unit, supported by the French Marine unit. It's a 3:1, with a plethora of modifiers: +2 (heavy attack) +2 (disrupted) +2 (Allied Combat chit) -2 (minefield) -1 (rough terrain) -1 (Axis Combat chit) = +2. The result is a massive /*RD, which kills the German unit. This attack also satisfies the requirements of the Withdraw/Attack chit.

May 29

The Allies get 4 activations, and the Axis gets 3. The activation and tactical chits are the same as the previous turn.

The Allies get 3 Armor replacements and two infantry battalions, from 29th Indian. This division has no activation chit, and so these units may be brought in only through an extra move chit or reallocating a formation chit. The Allies use their armor replacements to replenish units from 2nd and 22nd Armour, leaving the 4th Armour units understrength.

Gazala: The Cauldron

Just considering infantry losses, the Axis have 0 victory points.

All units are in supply. All disruptions have been removed.

In the minefield phase, the two breaches started by *Trieste* are completed. However, the presence of the Allied units on the opposite side of the hexes means that the breaches do not go all the way through both hexsides. This means that the Axis cannot trace a line of communications through the minefield as required, and so its activation limit is reduced by one, leaving it with only two activations this turn. The Axis places two minefield breach construction markers on *Pavia* regiments.

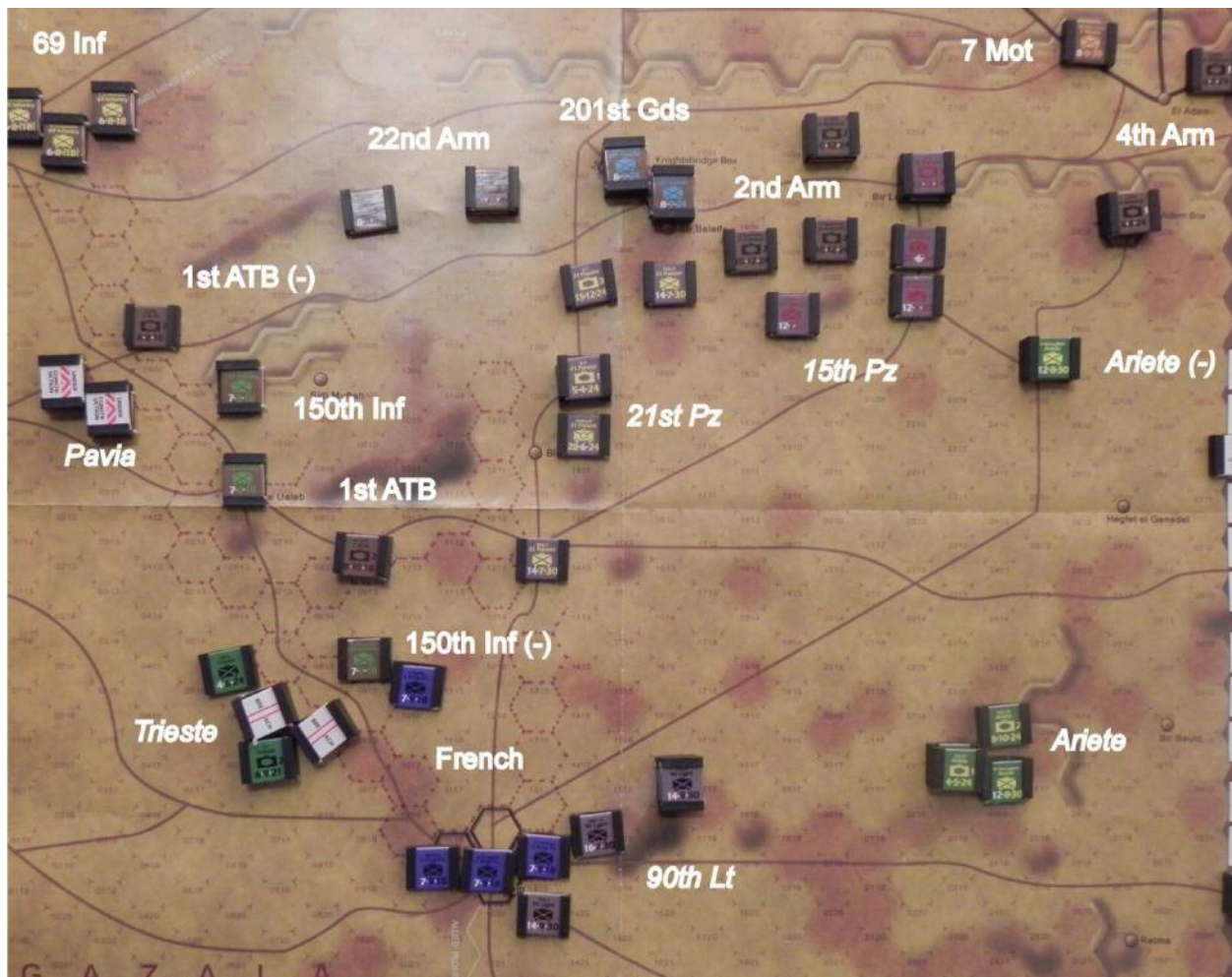

May 29 Start of Turn

The Axis gets the initiative.

The first Axis draw is *15th / 21st Panzer*. Since the campaign will be crippled if the action limit is reduced for very long, *21st Panzer* turns back to help the Italians. Leaving infantry and antitank units to keep an eye on *22nd Armoured*, the tank and one infantry unit reverse direction and attack the French 1 Pacific. The odds are fairly low, at 2:1, and the result is mutual loss of infantry units.

Gazala: The Cauldron

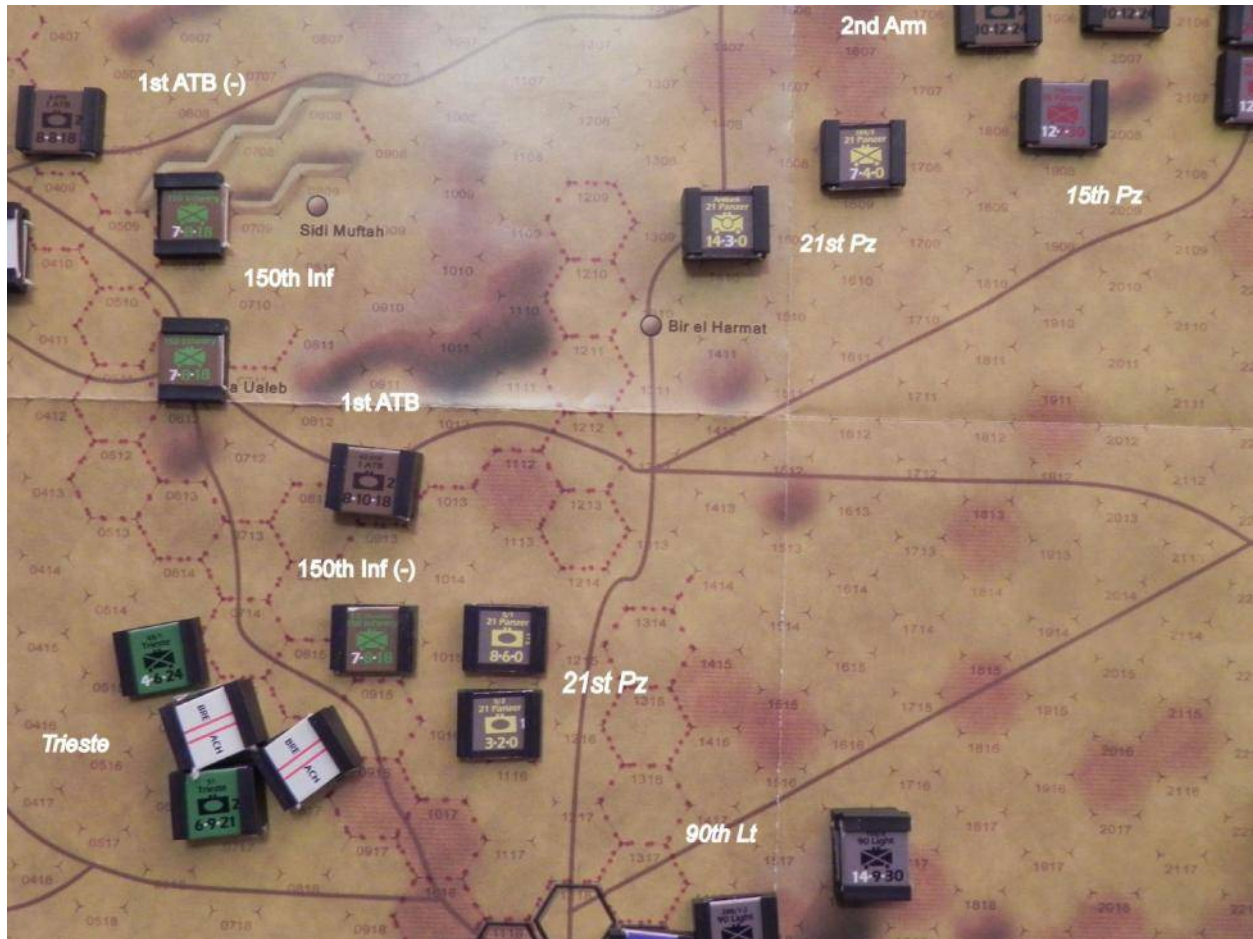

21st Panzer

The Allies draw Double Move. Unlike Extra Move, this is an activation chit, not a tactical chit. That means it has to be used right away. It allows any two units (not formations) to be activated. There are several things that the Allies could do. They could bring on their two reinforcement units. They could move two 201st Guards units out of the Knightsbridge Box to threaten the *21st Panzer* infantry (although they couldn't attack this turn, because it takes so many MP to cross the minefield). They could move units in the west to cover the minefield breaches that the Italians are opening up. They could mobilize two 1 ATB units to attack or cut off the *21st Panzer* tank units in "the triangle."

In the end, the Allies decide on that last option. Although the Matildas and Valentines of the two 1 ATB units (42 and 44 RTR) can't mount a strong attack against *5/1 Panzer*, even on its activated side, they can cut off its supply line with their ZoC. This might force the Axis to use their remaining activation to go to the panzers' relief, instead of doing something more aggressive with it. It's also possible that if the Allies get some good tactical chits and 1 ATB's own activation chit that it could mount an attack later with some prospect of success.

The Axis draws *90th Light / Pavia*. This isn't as good as drawing, say, *Ariete*, but it will do. *90th Light* pulls back its infantry from the Bir Hacheim perimeter to prevent another French sortie as in the previous turn. However, they still need to leave two battalions to protect the

Gazala: The Cauldron

supply line to the Panzers. They take their other infantry unit and their antitank battalion and move it into the gap between the minefields, thus reestablishing the supply line to *21st Panzer*. The antitank unit is positioned so that if 1 ATB activates again, it would have to attack it as well as *5/1 Panzer* (at least if it wanted a heavy attack). This is the Axis' last activation for the turn. Now they have to sit and take whatever the Allies can throw at them for three more activations.

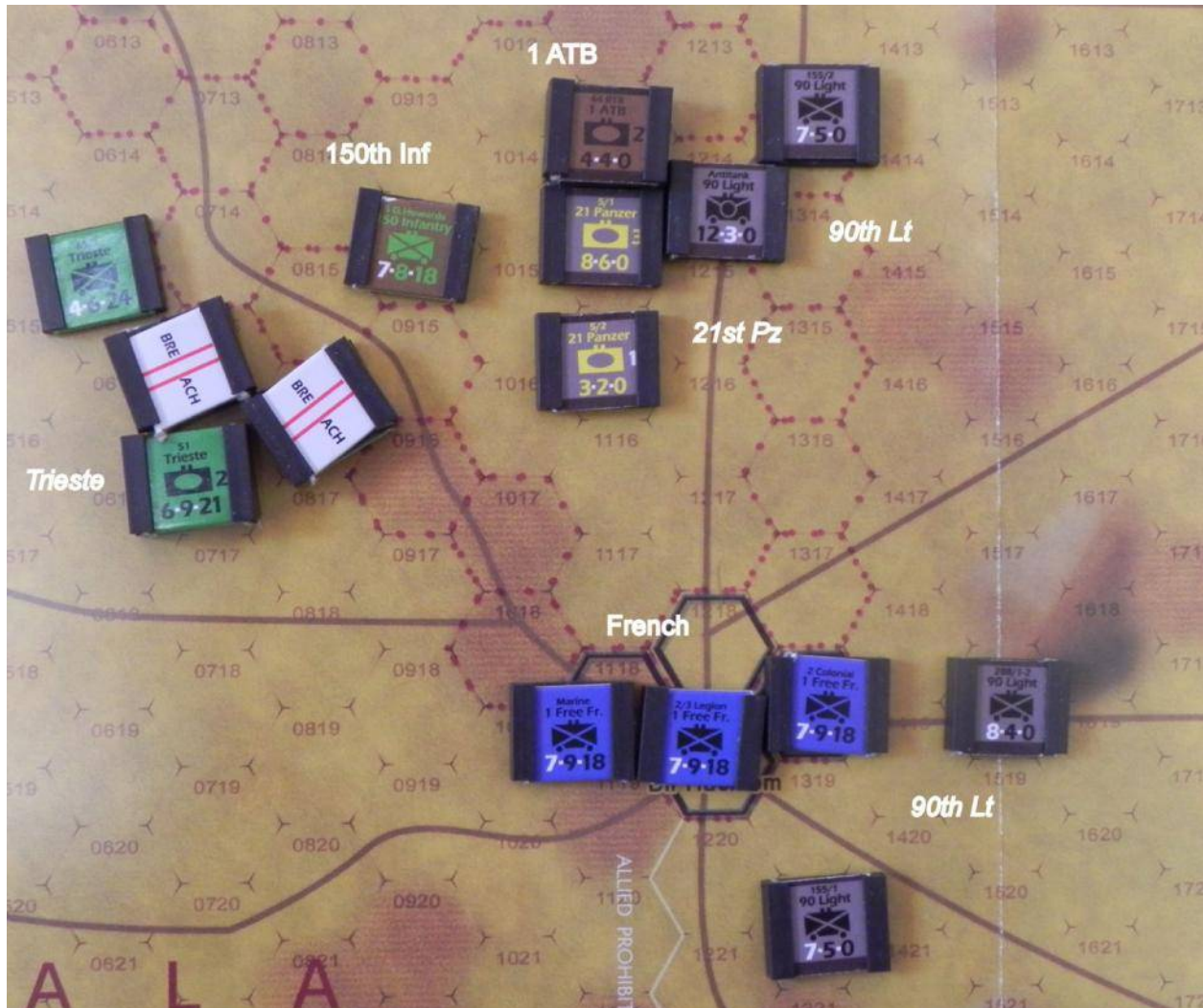

90th Light

The Allies draw Extra Move and 1 ATB. They don't have the combat-enhancing tactical chits they had hoped for. The low movement allowances of the ATB units will not allow one of them to pull out of their current position and attack *5/1 Panzer* from a hex that would not require attacking *90th Light's* antitank unit as well. In the end they both move into the minefield at 1213, which covers the exit to the triangle. This means that *90th Light* will have to keep its units in place until *Trieste* finally breaks through, which will take another two turns. The panzers will have to attack into the minefield if they want to clear an exit route. The other battalion of 1 ATB, 8 RTR, moves into one of the minefield hexes that *Pavia* is trying to clear, in order to prevent it.

Gazala: The Cauldron

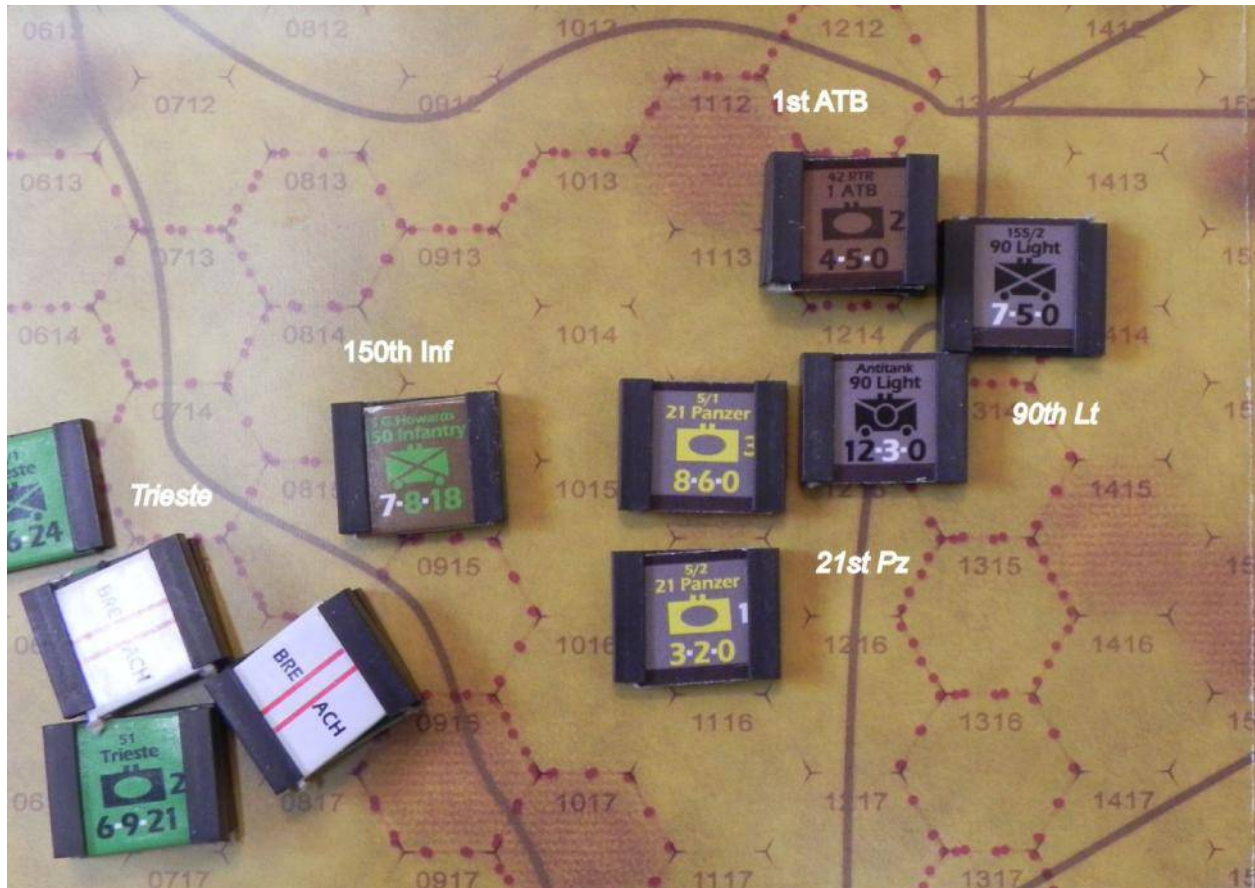

1st Army Tank Brigade

The next Allied draw is 7th Motorized. The Allied choose instead to activate 7 Green Howards, of 69th Infantry. This moves south to prevent *Pavia's* other minefield breach from pushing all the way through.

Gazala: The Cauldron

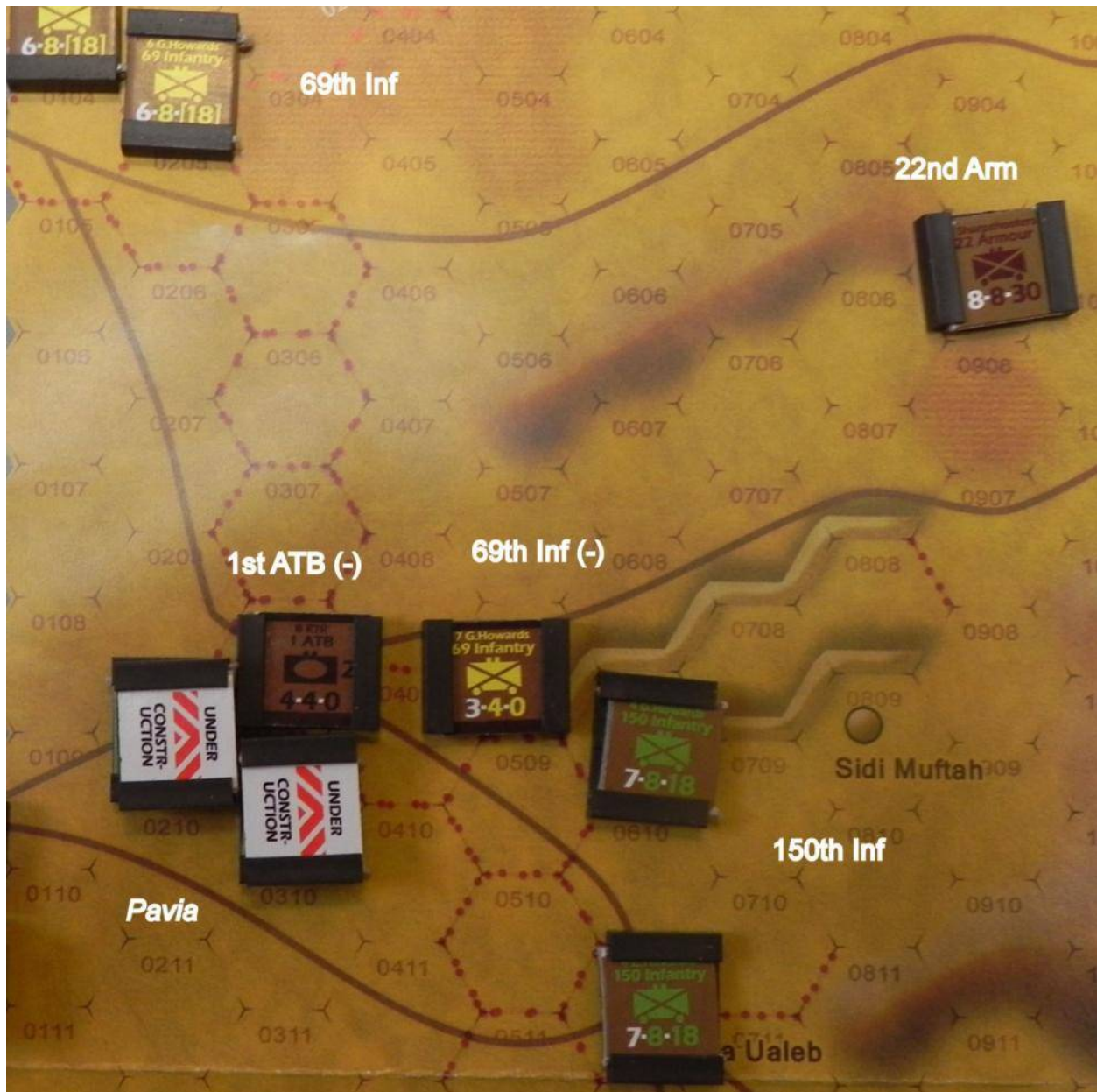

“7th Motorized”

The Allies’ final draw gives them 22nd Armour. This newly-replenished unit moves forward to recover the ground ceded by *21st Panzer’s* withdrawal. Their infantry unit occupies the northernmost minefield hex while the tanks move adjacent to *104/3 Infantry* (of *21st Panzer*). They are in little danger of attack, with *21st’s* tanks bottled up further south. The Allies use their Extra Move to bring on one of the reinforcement units, 6 Mahratta Light (of 29th Indian), which they zoom along the road to place adjacent to *104/3* as well.

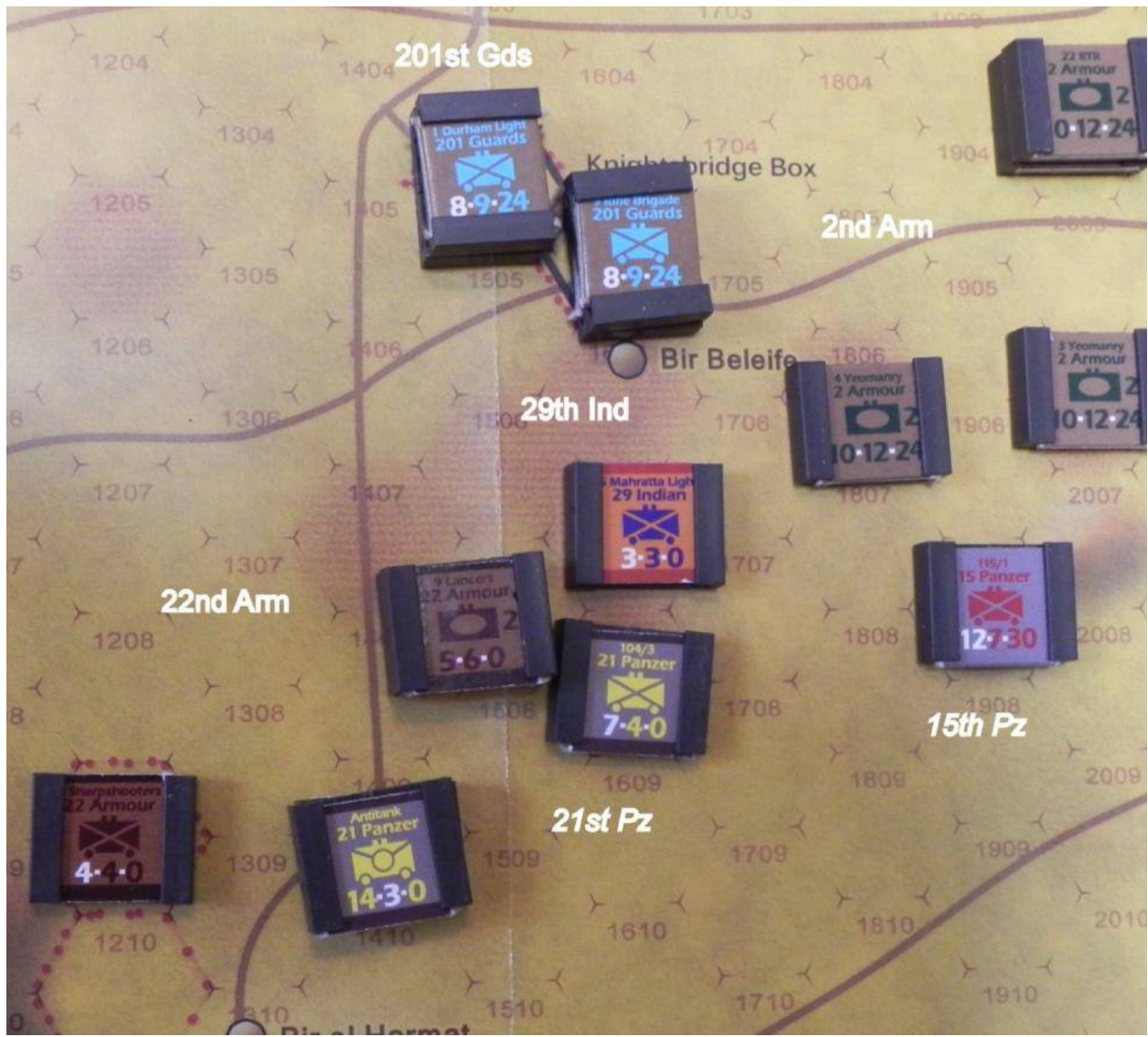

22nd Armour

May 30-31

Note that the turns start marking off more days per turn now.

The Allies' action limit is 4. The Axis limit is 5, reduced by 1 for not having a path through the minefields, making it 4 as well. The Axis adds additional activation chits for *15th / 21st Panzer* and *Ariete / Trieste* to its cup.

No reinforcements are due this turn, but the Allies still have an infantry battalion yet to enter from last turn.

In the minefield phase, one of *Pavia's* breaches is successful, but the other fails due to the presence of British tanks. The Axis decides to start only one new breach this turn, in the *Trieste* area. The total number of breach markers is limited. At present, *Pavia's* only opportunity is in

Gazala: The Cauldron

the hex that just failed. It's possible that the *Trieste* unit could put a breach all the way through in one turn, if the Allies are too busy to block it.

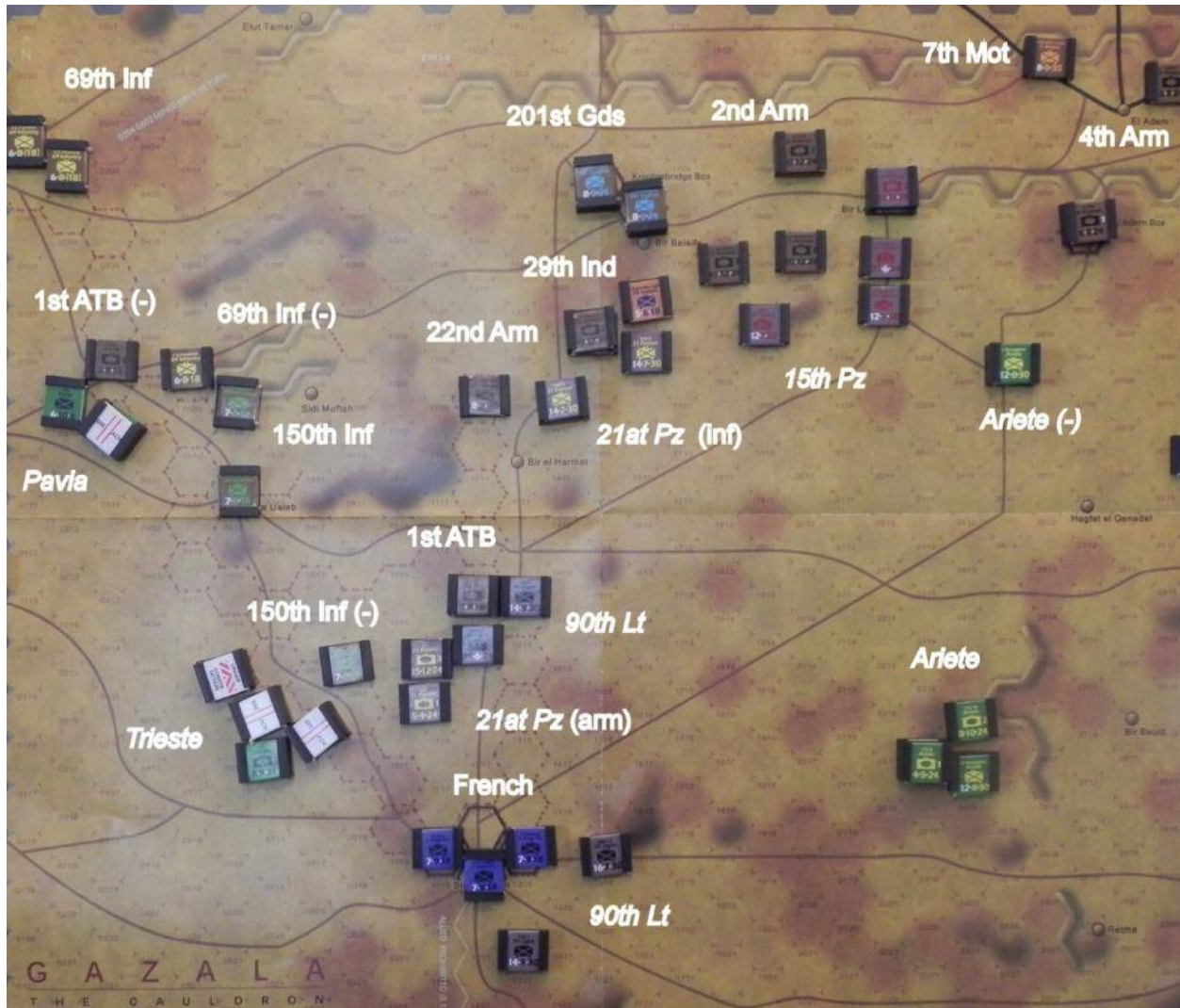

May 30-31 Start of Turn

The Axis gets the initiative. They draw *15th / 21st Panzer* and choose to activate *21st*. First they move their antitank unit south so that it can support the upcoming attack on 1 ATB. Then *5/1* spearheads the attack into the minefield, supported by their own antitank and *90th Light's*. It's a 3:1 attack with a -2 DRM. The result is that 1 ATB must retreat, although no losses are suffered on either side. The Germans may not advance after combat because of the minefield. Instead, *5/1* continues its turn by surrounding 5 Green Howards (150th Infantry), and *5/2* tags along behind to provide security. While they could attack, the odds would be fairly low. The hope is that *Trieste* will activate, and then the panzers can support the Italians. In any case, 5 Green Howards is now surrounded by ZoCs and can't move. If it survives the turn, it will be out of supply.

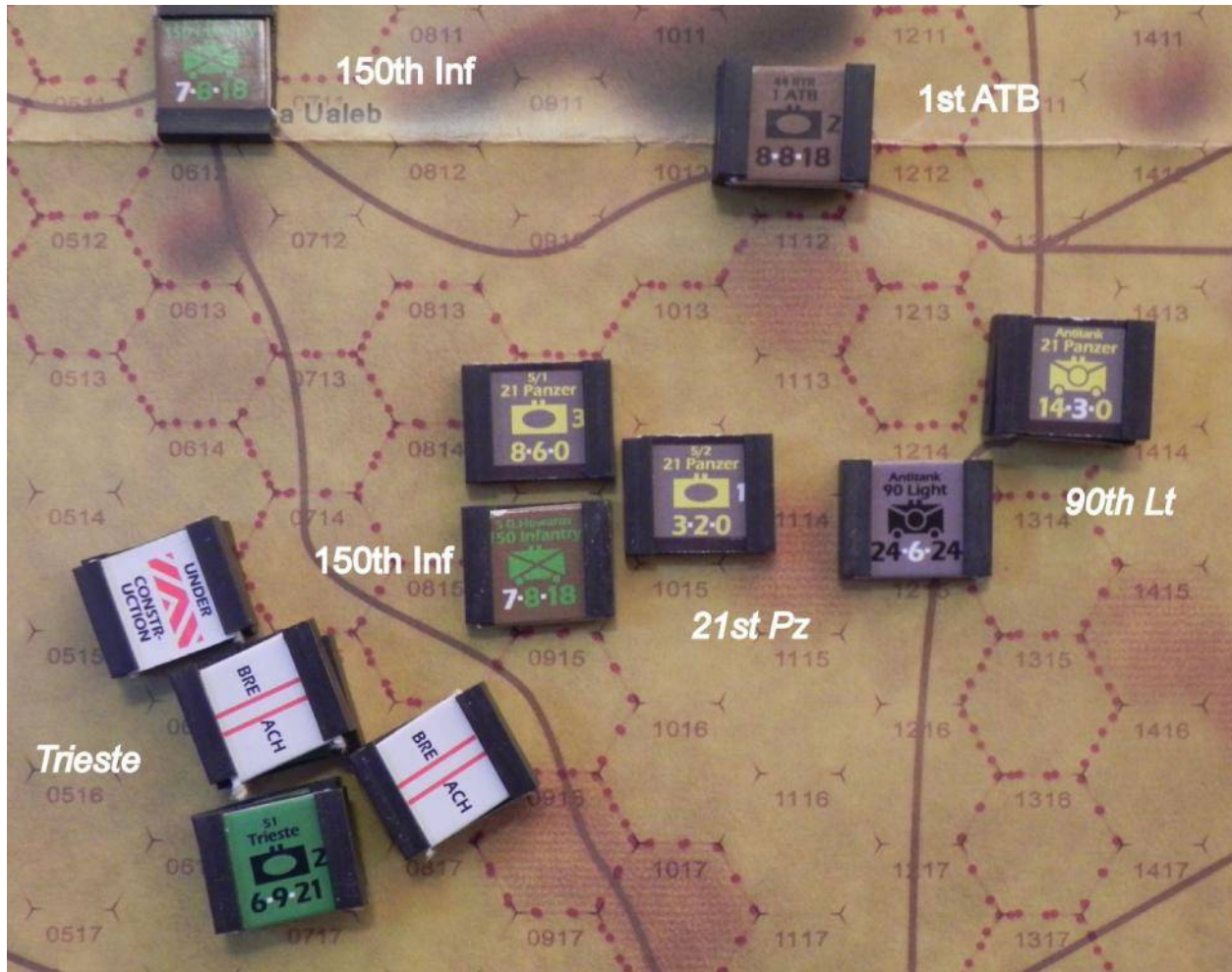

21st Panzer

The Allies draw 7th Motorized. They use the chit to activate 5 Mahratta Light (29th Indian), which launches a heavy attack against 104/3 (21st Panzer), “supported” by both tank battalions of 22nd Armour. However, the Germans stand their ground, and the Allied units must retreat.

Gazala: The Cauldron

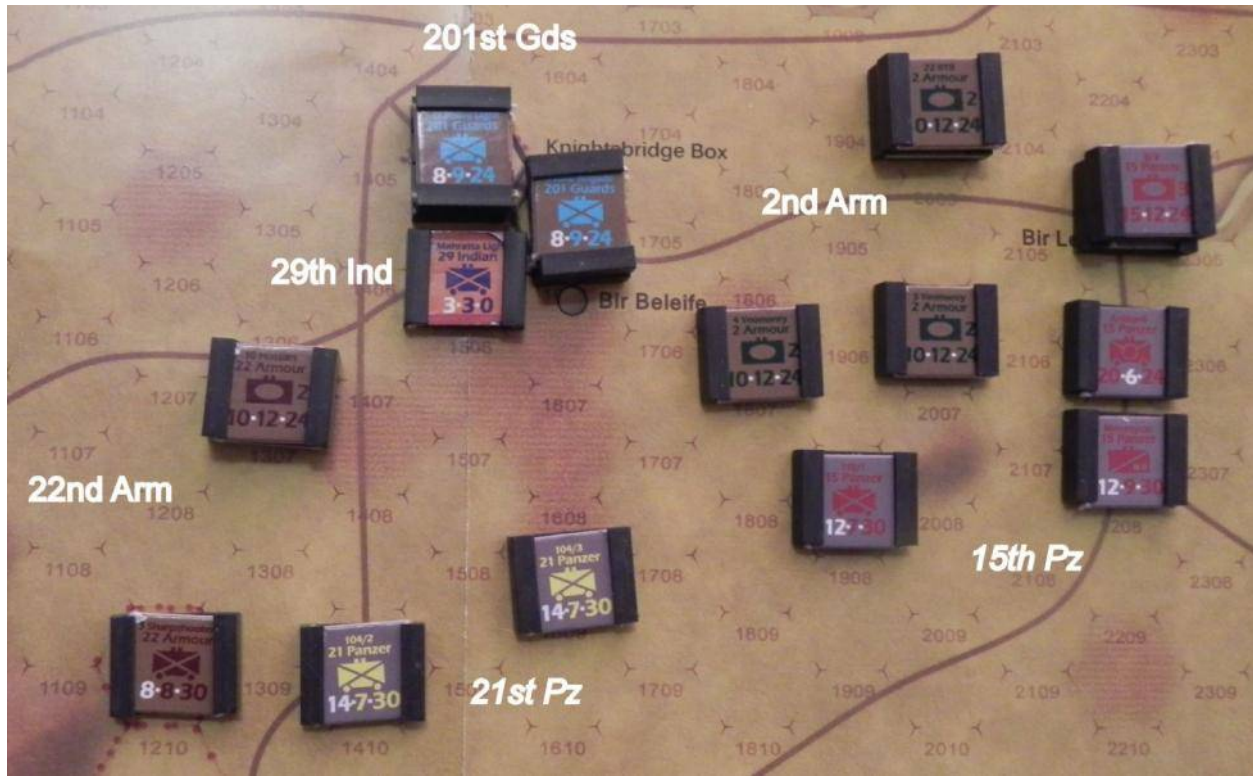

“7th Motorized”

The Axis draws *90th Light / Pavia*. They activate *Pavia*, moving its two regiments through the gap in the minefield.

Gazala: The Cauldron

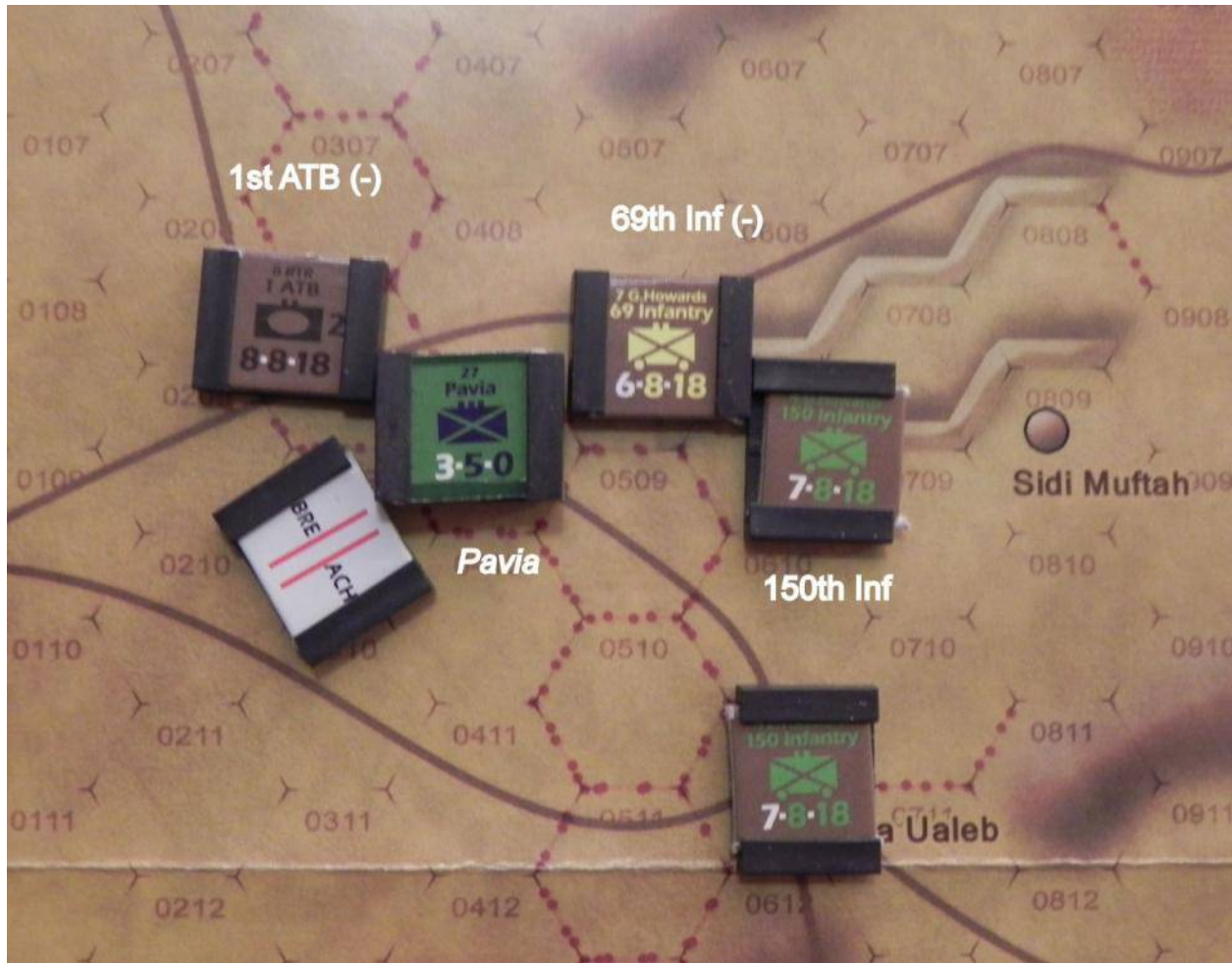

Pavia

The Allies draw Extra Move and then 2nd Armour. This brigade is holding a pretty good defensive line against *15th Panzer* but isn't strong enough to launch an attack. Instead, the Allies move 3RTR (4th Armour) a bit west of El Adem, to prevent the Axis from just walking into that victory point hex.

Gazala: The Cauldron

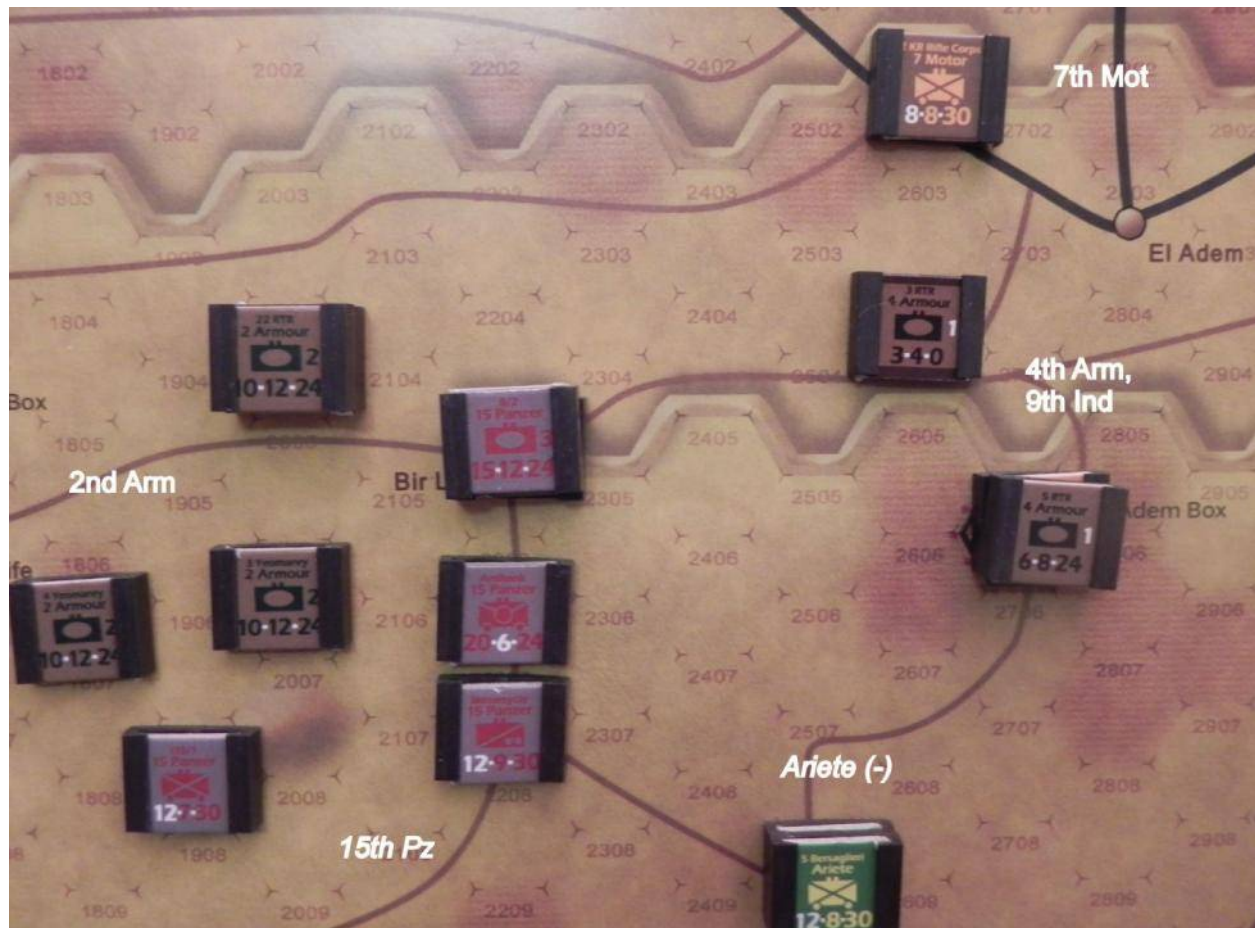

“2nd Armour”

The Axis draws Extra Move, Combat, Armor Replacement, and *Ariete / Trieste*. As planned, *Trieste* surges through the breached minefields and attack 5 Green Howards. It’s a 3:1 attack, with the Combat chit partially compensating for the minefield. The British unit is eliminated.

Gazala: The Cauldron

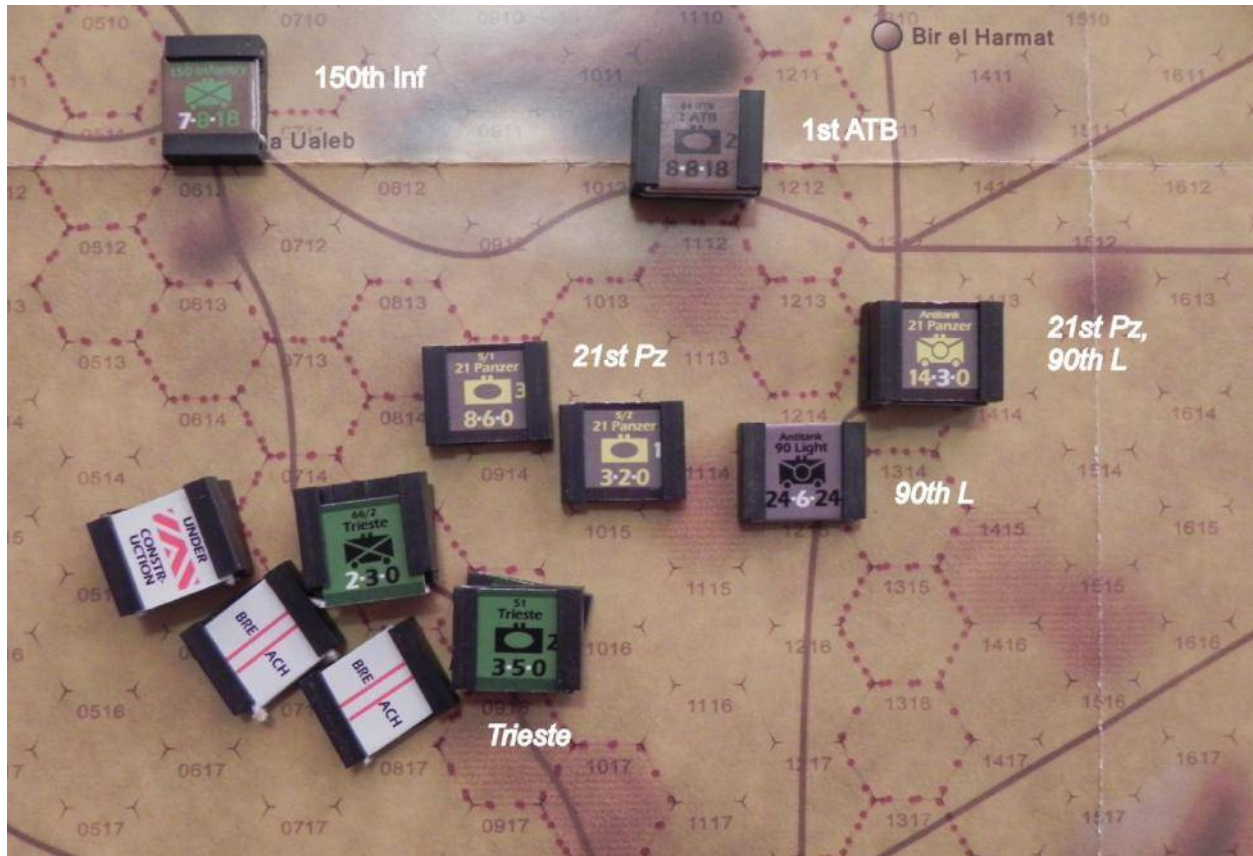

Trieste

The Allies draw Armour replacement, Airstrike, and Double Move. The airstrike succeeds in disrupting *104/2 Infantry* (of *21st Panzer*). The Allies try to take advantage of this situation by playing Extra Move and activating the two battalions of *29th Indian* (one of which is still off map) and *3 Sharpshooters* (of *22nd Armour*) to attack the German infantry. The 2:1 attack with a +2 DRM merely forces the Germans to retreat. *3 Sharpshooters*, the active unit, pursues, in the hopes of setting up a heavy attack when the *22nd Armour* chit is drawn.

Gazala: The Cauldron

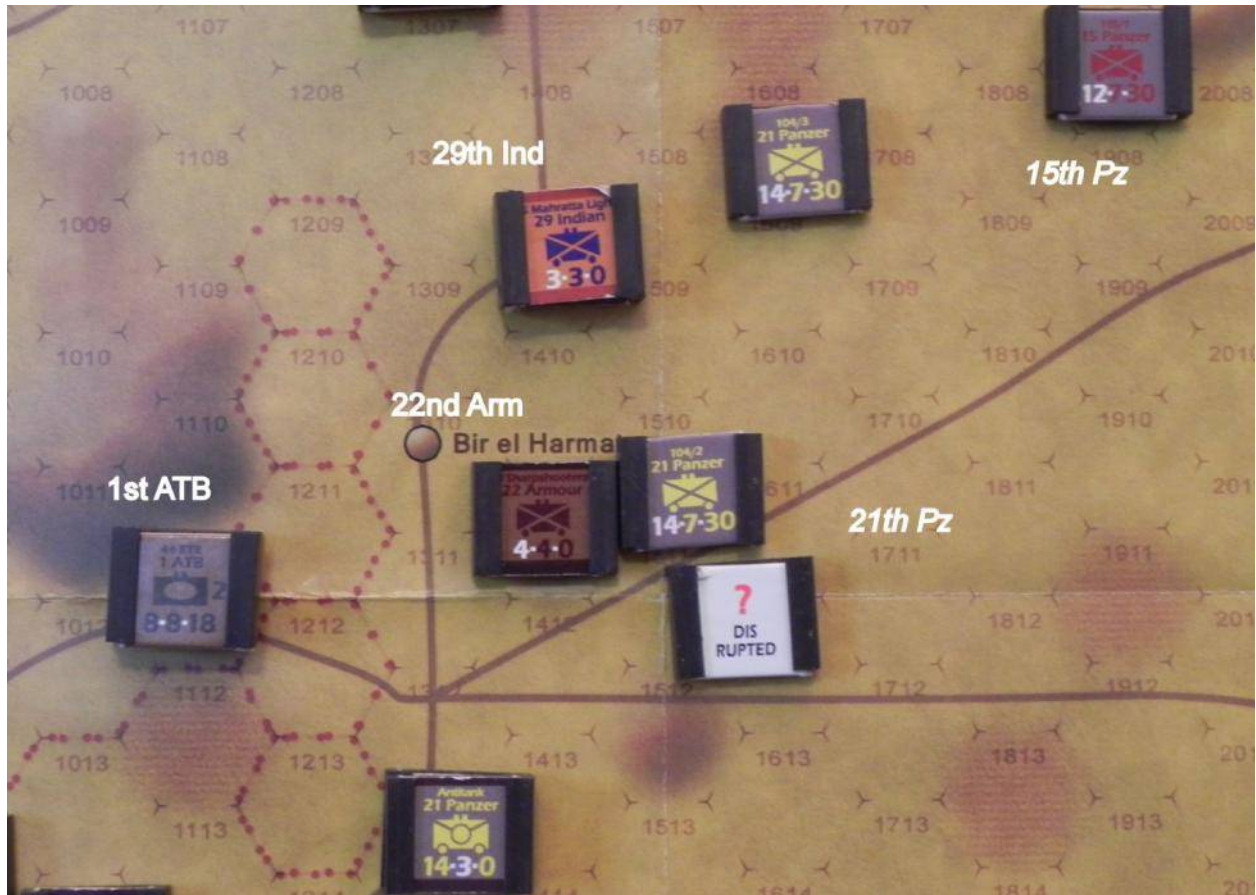

Double Move

The Axis draw Sandstorm and the 15th / 21st Panzer. They use their Armor Replacement to add a step to 5/2 Panzer. They use Extra Move to activate 152/2 Infantry (of 90th Light) to move into contact with 3 Sharpshooters, so that the anticipated attack will have to include two German defenders instead of one. Since the sandstorm precludes any offensive activity, the Axis activates 21st Panzer, which redeploys its tank units out of the triangle and back north, where the division will be able to renew its offensive next turn.

Gazala: The Cauldron

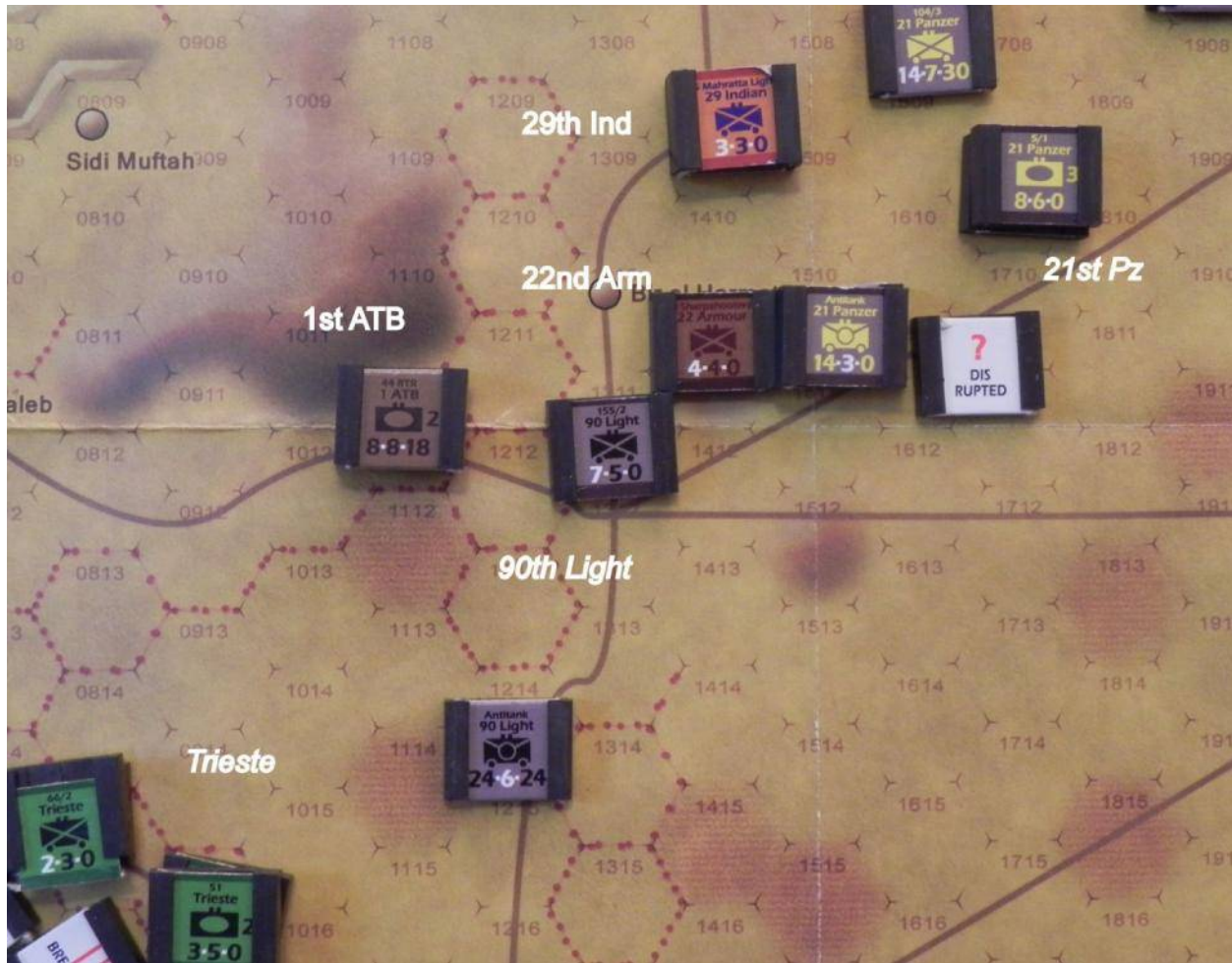

21st Panzer

The Allies draw 22nd Armour. Since this is their last activation of the turn, they use their Armour Replacement to bring 3RTR (4th Armour) up to full strength. With the redeployment of *21st Panzer*, their planned attack is a no-go. Instead, they bring their armour down to join 3rd Sharpshooters in an attack on 152/2. The result is disruption of the defenders, but, given that this is the last activation of the turn, that is meaningless.

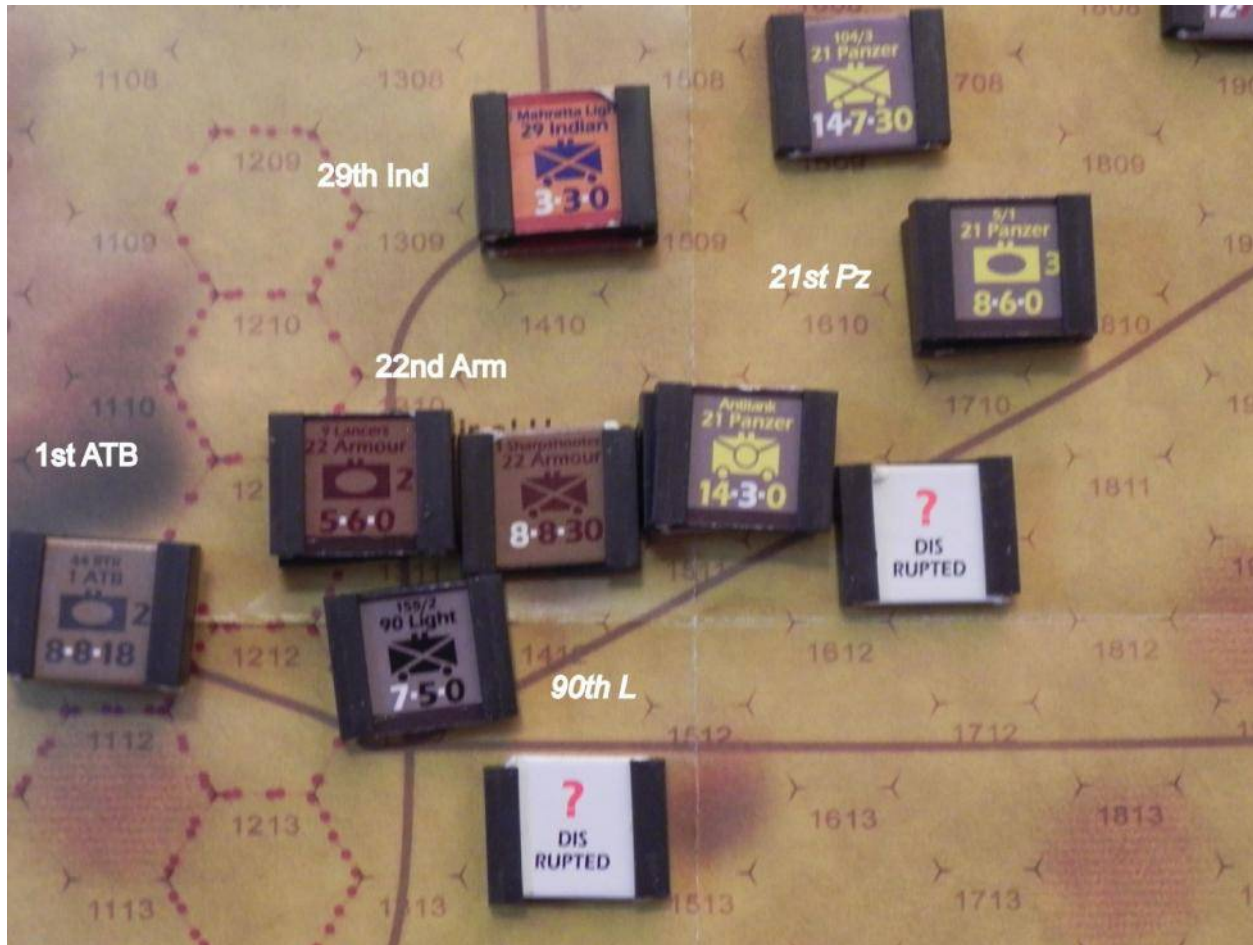

22nd Armour

June 1-2

The Allies have but a single activation this turn. The Axis is due 5. One *Ariete / Trieste* chit is removed from the cup.

The Allies get two armour steps as replacements. They use one to replenish 5 RTR and the other to rebuild 8th Hussars, both of 4th Armour. They also get reinforcement, 9th Durham Light Infantry, of 151st Infantry.

In the minefield phase, Trieste succeeds in breaching one minefield all the way through. However, at this point the Axis needs two such lanes to avoid penalty. Thus, their action limit is reduced to 4. They set breach construction markers in the *Pavia* and *Trieste* areas. The *Pavia* attempt could easily be blocked, but with the Allies so short of actions this turn, it's worth the try.

Gazala: The Cauldron

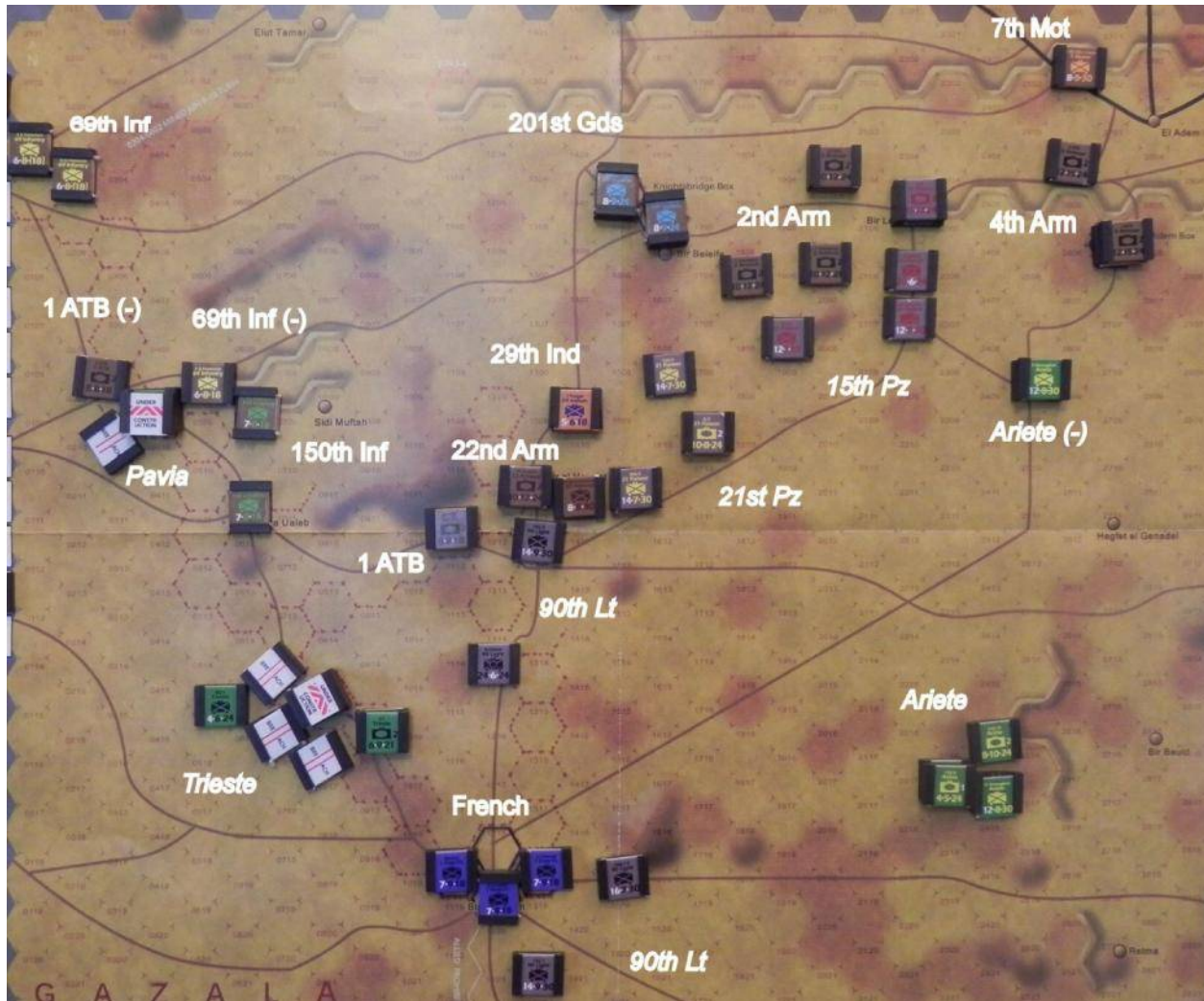

June 1-2 End of Minefield Phase

All units are in supply.

The Axis has the initiative.

The Axis draws *15th / 21st Panzer*. *21st's* tank units move up to support *104/2* in an attack on *3rd Sharpshooters*, also supported by *152/2*. It's a 3:1 heavy attack (+2), with -1 for terrain. The result is an exchange. Then *104/1* surrounds *29 Indian* and attacks, supported again by the division's tanks. This is another exchange. Thus, *21st Panzer* has stripped itself of infantry, albeit destroying two Allied infantry units along the way.

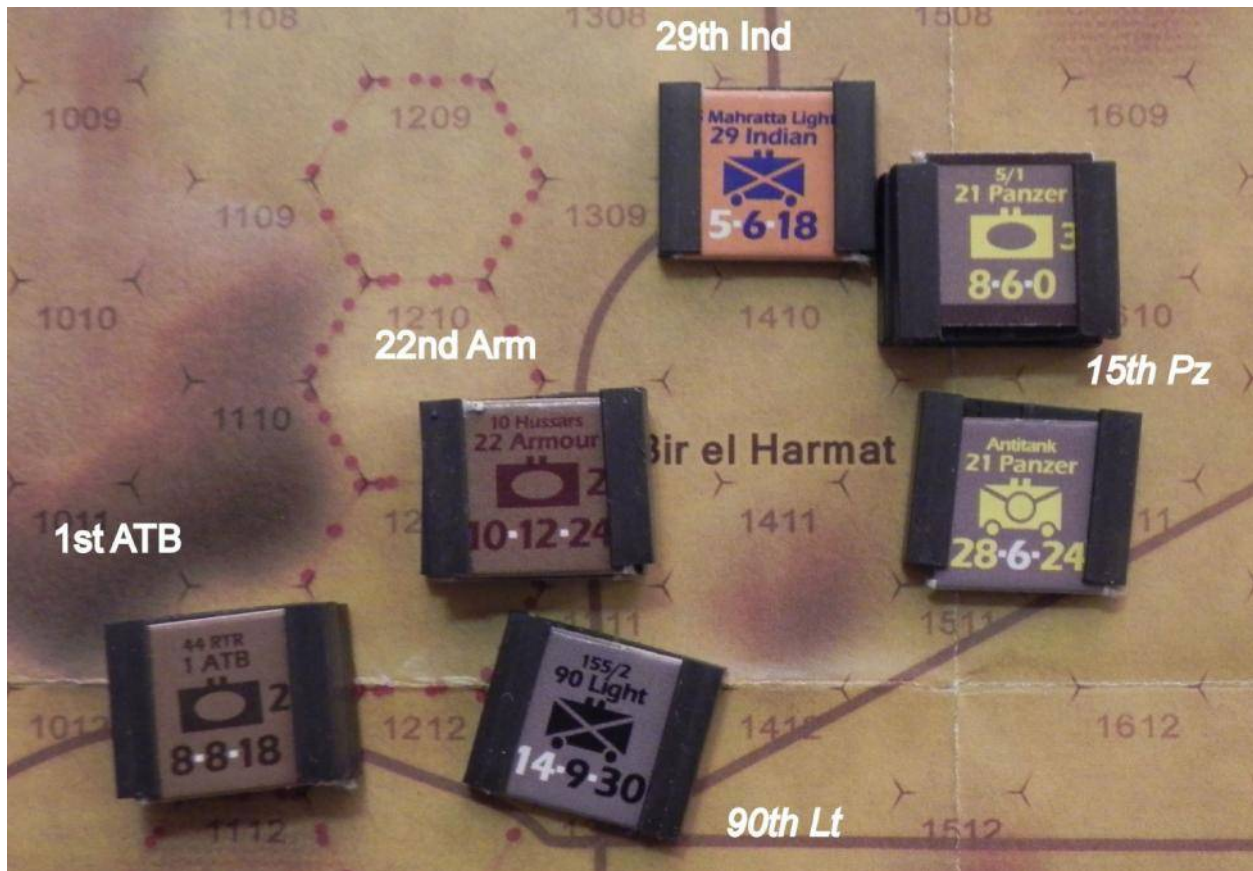

21st Panzer

The Allies get their one activation, and it is 22nd Armour. They too are now sans infantry. Given that they will have to weather three more Axis activations, they pull back to the rough terrain south of Knightsbridge, where they will be harder to surround.

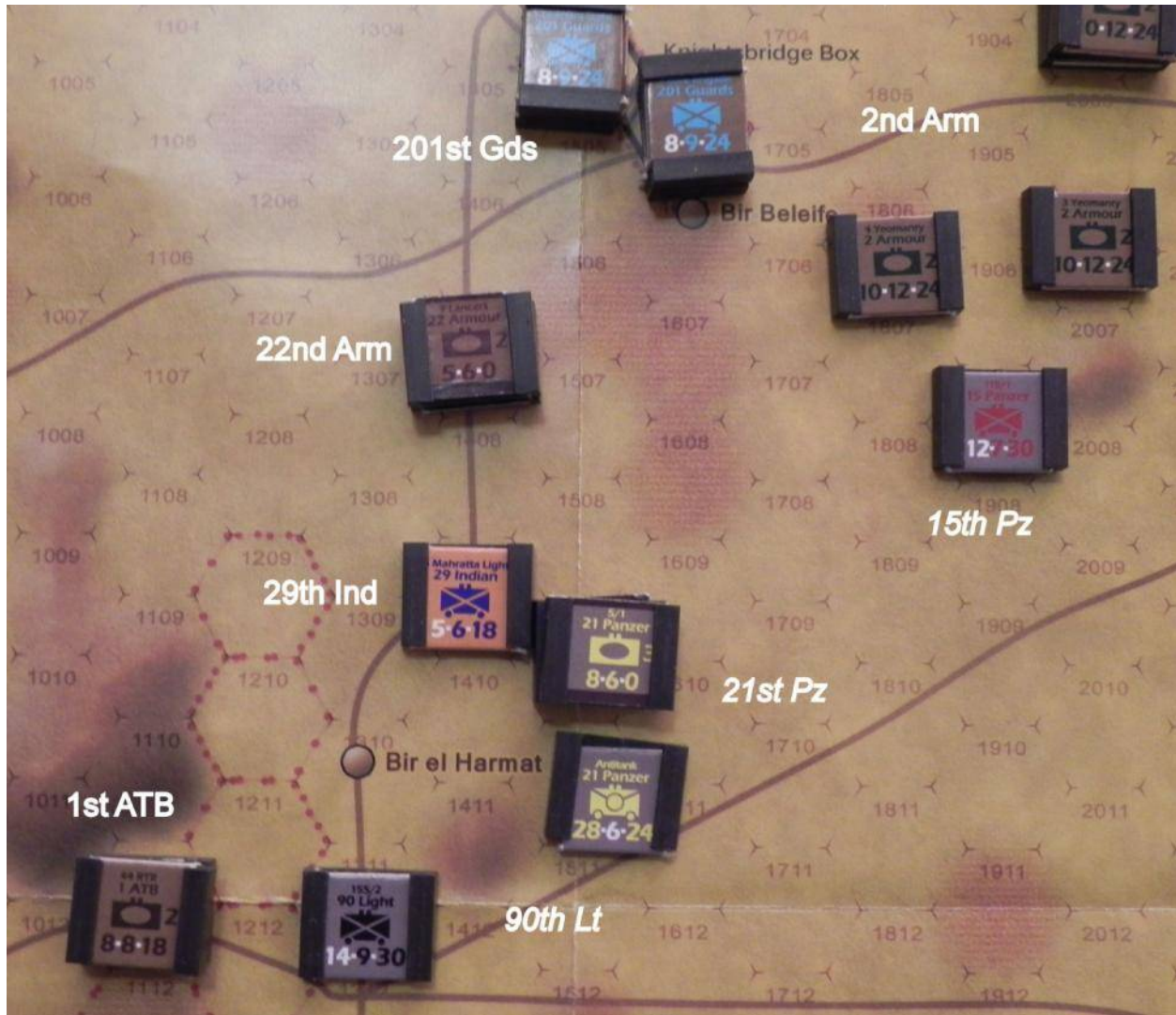

22nd Armour

Now the Axis has three activations that they can take in the secure knowledge that they will not be interrupted. They draw Combat and then *90th Light / Brescia-Pavia*. Instead of activating any of those, they choose to use *8/1/15th Panzer*. The unit moves into contact with 2nd Armour. The idea is to set up a stronger attack when the whole panzer division activates later in the turn.

The next chit to be drawn is indeed *15th / 21st Panzer*. This flips *8/1* back to its inactivated side. First the Germans move up the division's antitank unit in support. Then they attack with *8/2*, throwing in the Combat chit. But it's all for naught, as the result is no effect. Plan B is for *8/1* to launch a heavy attack, supported by *8/2* and the antitank unit. This drops the odds to 3:2, but with a +2 DRM. However, the result is still no effect.

For their final activation, the Axis draws Antitank, Extra Move, Sandstorm, Armor Replacement, and then *15th / 21st Panzer*. They use the replacement chit to replenish *Ariete's 132/8*, since *5/1 Panzer* is in contact with 29th Indian. They use Extra Move to activate *Trieste's 65/1*, which crosses the minefield to screen against a return of 1st ATB. Then *15th Panzer*, with all units on their inactive sides, attack 2nd Armour yet again. It's a 2:1 attack, -2 for a light attack, using the

Gazala: The Cauldron

Antitank chit to do some extra damage. Their luck holds steady, and, for a third time, the result is no effect. However, the Antitank chit reduces 22 RTR regardless of the combat results.

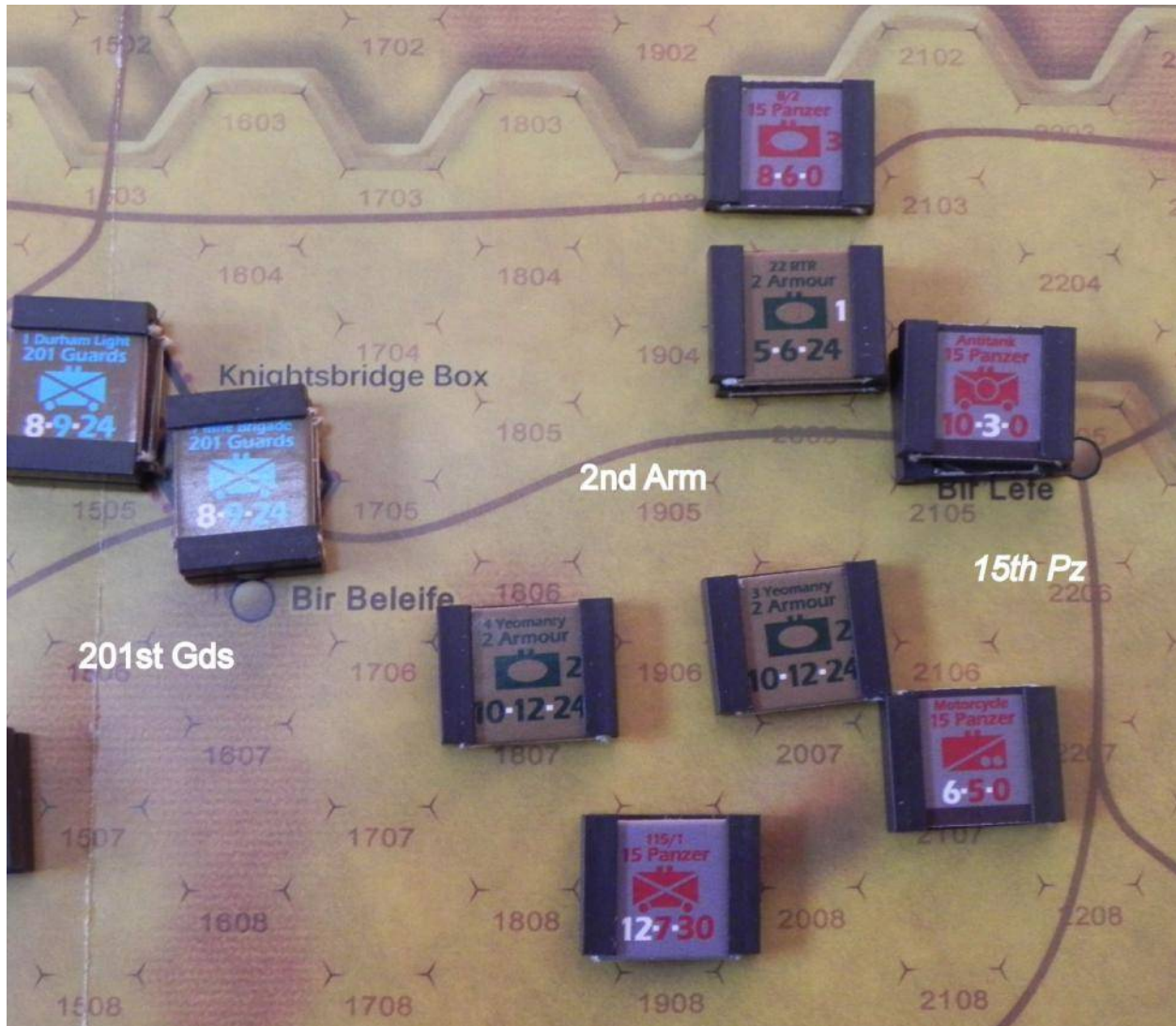

End of Axis Activations

June 3-4

The Axis gets 1 action this turn, and the Allies get 4. Panzer divisions have no activation chips in the cup. On the Allied side, the only activation chits are 9th Indian, 10th Indian, 7th Motorized, and Double Move. So none of the major armoured formations, except for *Ariete*, can be activated this turn.

The Allies get a slug of reinforcements, including 9th Indian, 10th Indian, and the independent Cumberland infantry battalion. They did not bring on the previous turn's reinforcements, which means that 8th Hussars and 9th Durham Light Infantry are waiting to enter.

Gazala: The Cauldron

In the minefield phase, *Pavia* and *Trieste* both complete their work. The *Pavia* breach is blocked by Allied ZoCs and can't function as a line of communications, but there are now two such lines passing through the *Trieste* sector. Thus, the Axis does not lose their only activation this turn. However, they decide to drive one more breach in the *Trieste* sector since, once completed, it will constitute a lane that uses only one breach marker.

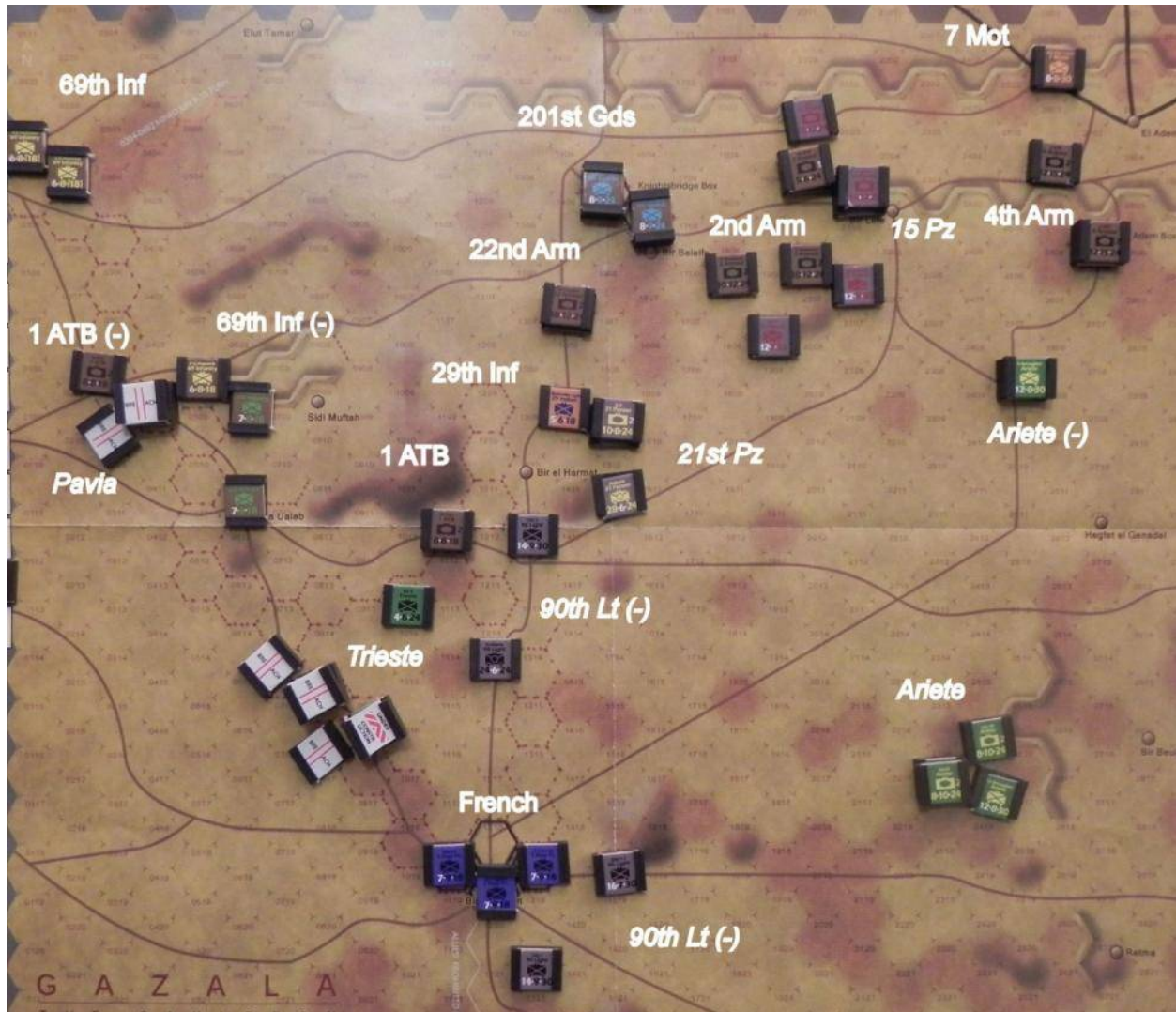

June 3 After Minefield Phase

The Germans have the initiative. They decide that they don't want to let the Allies activate four times in a row without being able to react. So, they decide that the Allies will make the first activation.

The Allies draw Sandstorm, Airstrike, and Double Move. Because Airstrike was drawn after Sandstorm, it has no effect. The Allies activate 8th Hussars and bring it on-map to join up with its brother 4th Armoured unit, 3RTR. It then activates 5th Mahratta Light (29th Indian) and moves it out of contact from *21st Panzer*, so that the Germans can't launch a heavy attack against it this turn.

Gazala: The Cauldron

The Axis draws Antitank, Extra Move, and *Ariete* / *Trieste*. This is a difficult choice. On the one hand, *Ariete* has been sitting around in the southeastern corner of the map for several turns. On the other, most of *Trieste* is still sitting on the minefield line. The Axis decides to move *Ariete* to the northwest, where it strengthens the position of the much-depleted *21st Panzer*. They use Extra Move to activate *8/1 Panzer*, of *15th Panzer*, which launches a heavy attack against 22 RTR and 1 Rifle Brigade of 2nd Armour. The German attack is supported by *8/2 Panzer* and the division's antitank unit. The odds are 3:1, +2 for the heavy attack, and the Axis throws in the Antitank chit. The combat result is simply a retreat, but the extra chit eliminates 22 RTR.

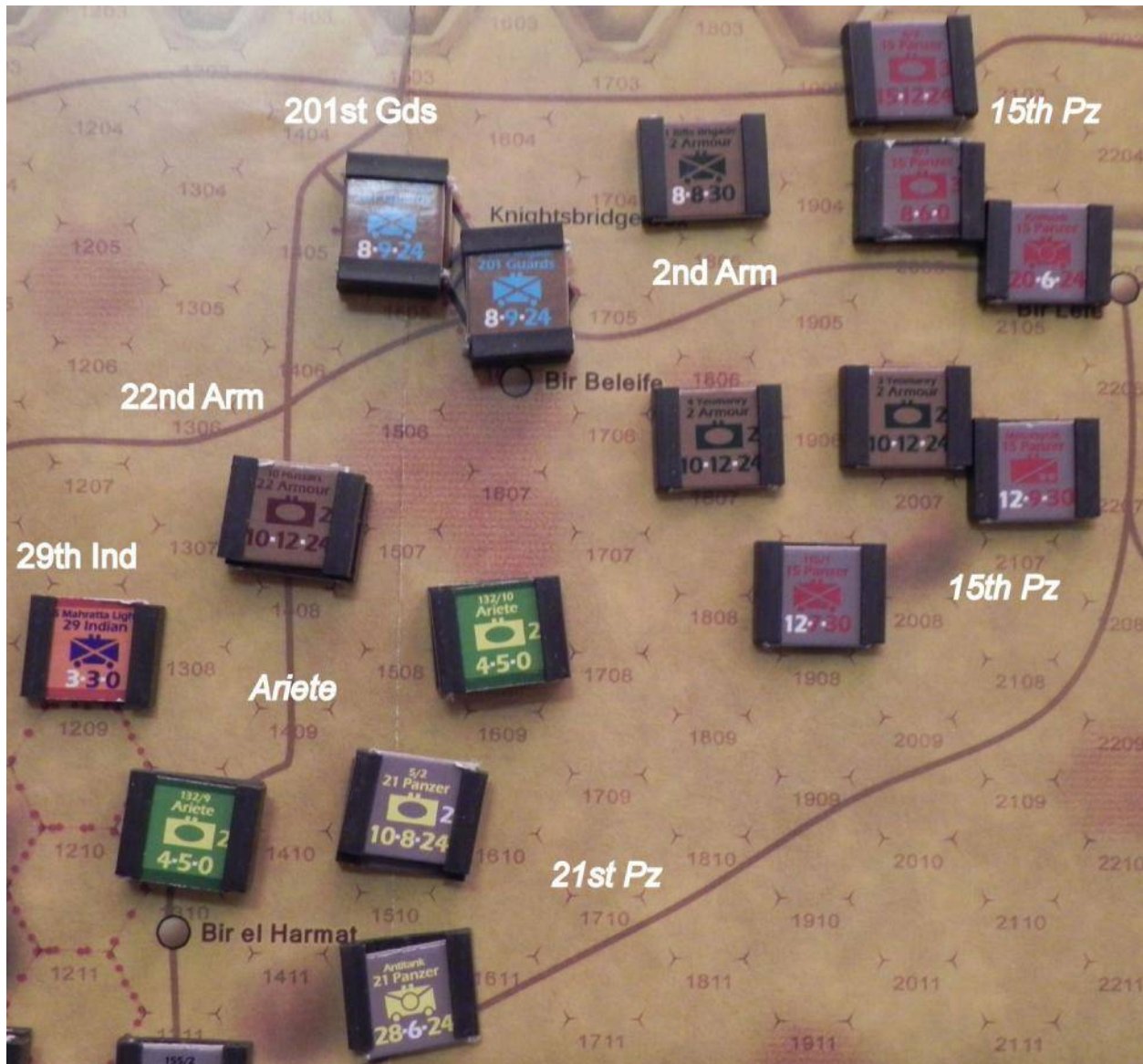

Ariete

The Allies draw Combat, Withdraw / Attack, Armour Replacement, Extra Move, and 9th Indian. 9th Indian consists of three motorized infantry battalions, one of which is already on the map, in the El Adem Box. The Allies use Extra Move to activate 5 RTR (4th Armour) and move it out

Gazala: The Cauldron

of the El Adem Box to the point where the track crosses the escarpment outside Bir Lefe. This cuts off the supply line to *15th Panzer's* tank and antitank units. Then the Allies bring on the two remaining battalions of 9th Indian. One joins its fellow in the El Adem Box. The other stacks with 5RTR.

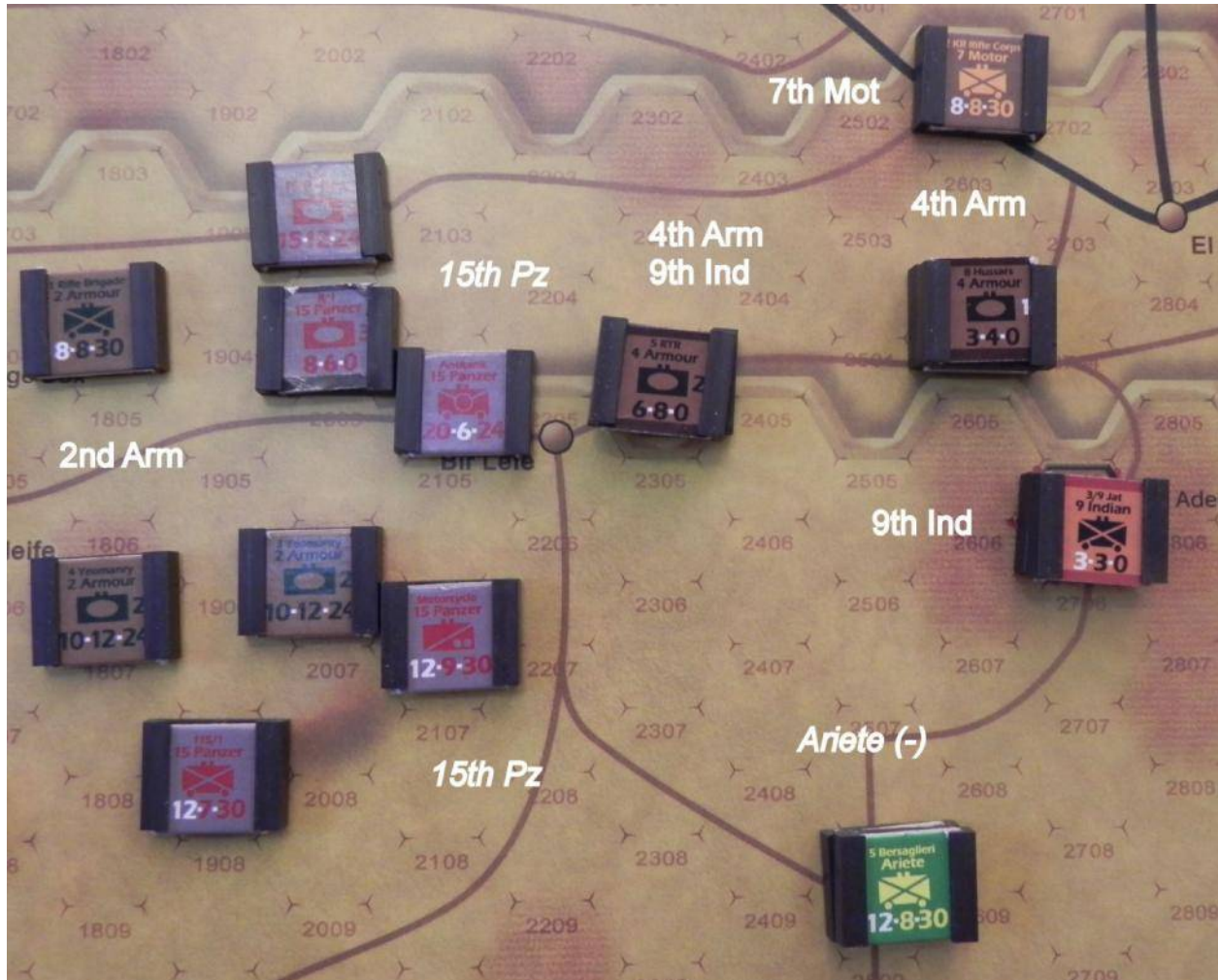

9th Indian

The Allies draw 10th Indian, another 3-battalion formation. They move into the rough terrain on either side of the Knightsbridge Box. This will free up the armoured units holding those positions for more mobile operations.

Gazala: The Cauldron

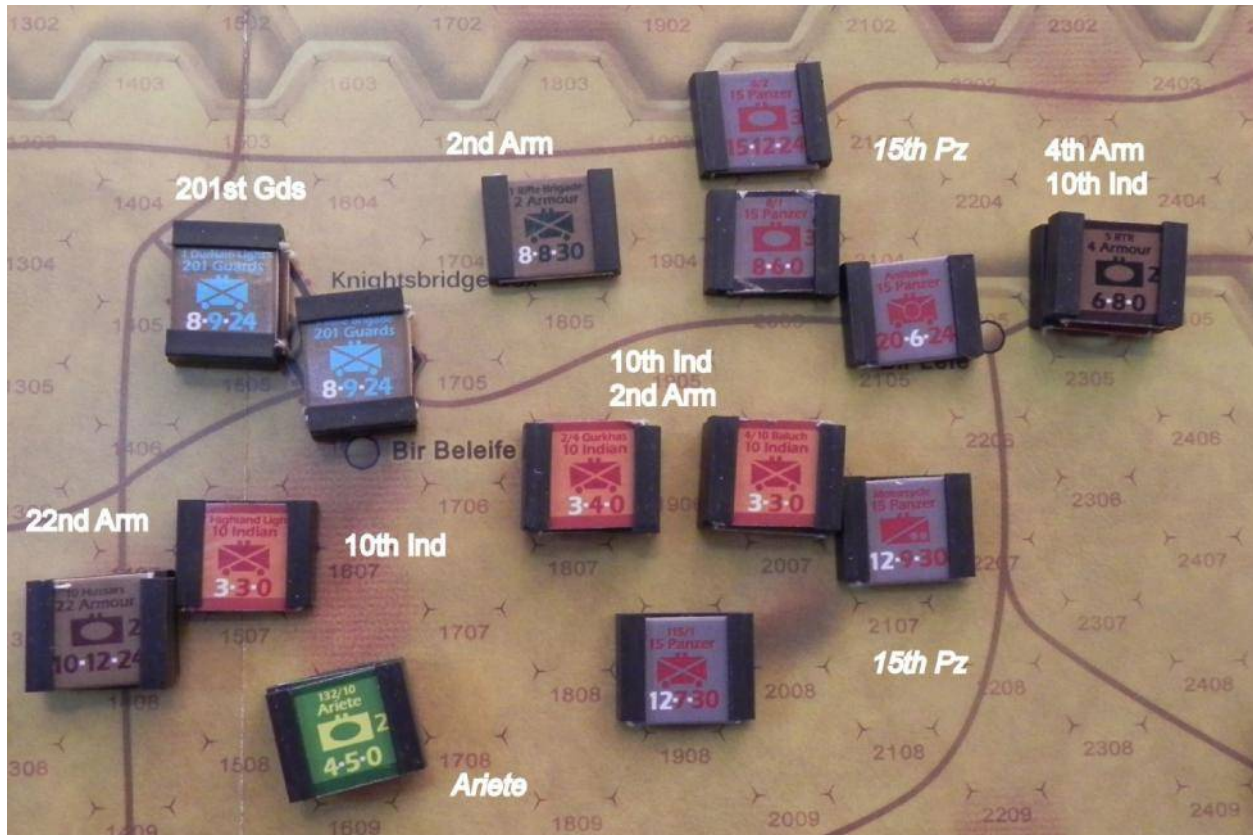

10th Indian

The Allies draw 7th Motorized. First, they use Armour Replacements to place 2 Dragoons (22 Armour) back on the map, at depleted strength. Then they use Withdraw / Attack to take 7th Motorized out of the battle. It consists of only one unit at this point, and removing its chit from the cup will increase the chances of activating better formations.

June 5-6

The Axis gets 5 activations, and the Allies get 6. The Allies get all their activation chits back, but Double Move is removed. The Axis has all of theirs available, including two for *Ariete* / *Trieste* and three for *15th* / *21st Panzer*.

The Allies get more reinforcements in the form of two tank units from 32nd Army Tank Brigade. They still have two British motorized infantry battalions yet to enter from previous reinforcements.

8/1 and *8/2 Panzer* of *15th Panzer*, plus that division's antitank unit, are out of supply.

In the minefield phase, *Trieste* completes the breach it started in the previous turn. The Axis starts no new breaches this turn.

Gazala: The Cauldron

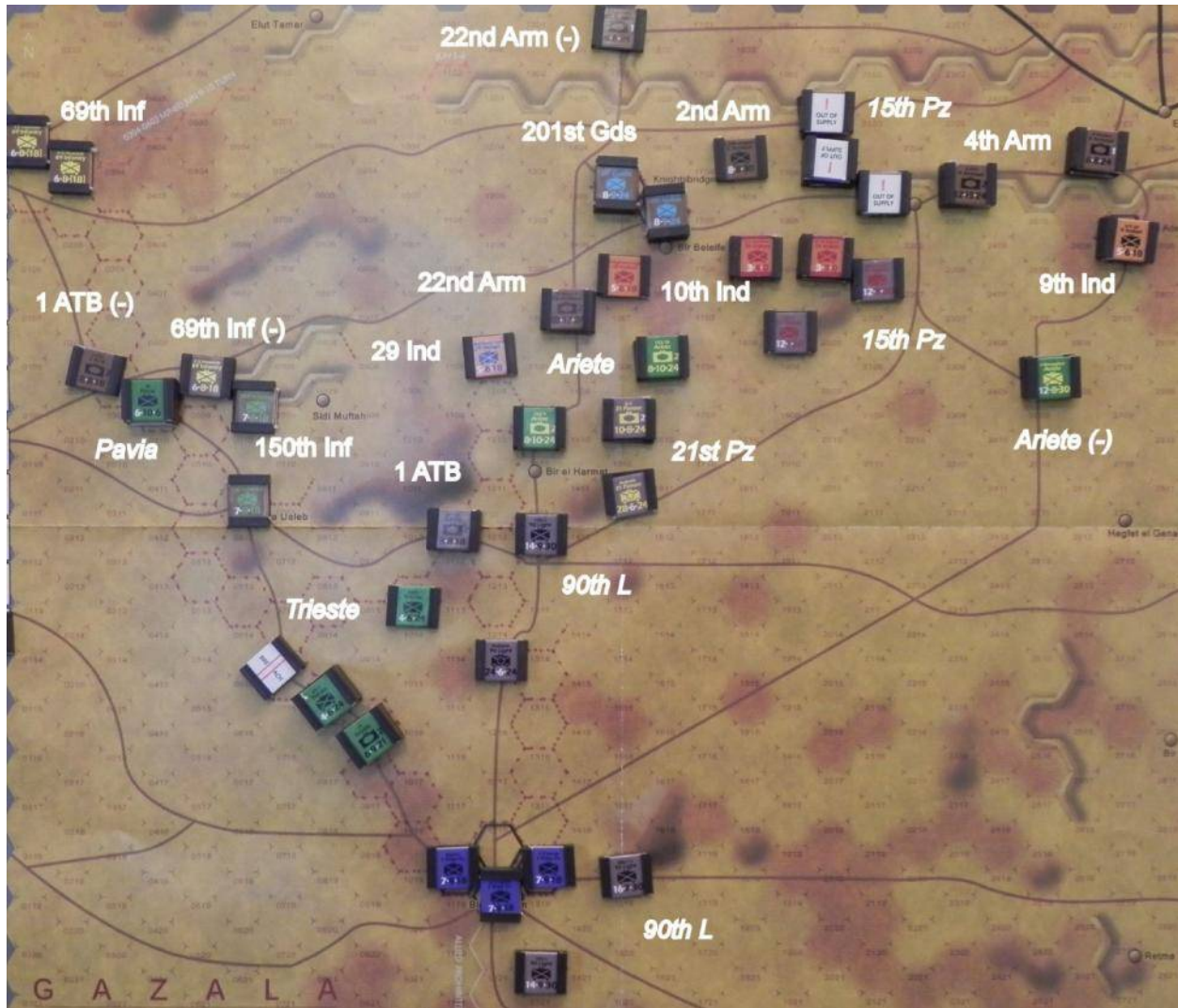

June 5-6 After Minefield Phase

The Axis gets the initiative.

The first draw is *15th / 21st Panzer*. *21st Panzer* swings to the east in order to rescue *15th*. However, they don't attack. It would be only a 2:1, and they can't afford any more losses. They're hoping to get an opportunity for a heavy attack later in the turn.

Gazala: The Cauldron

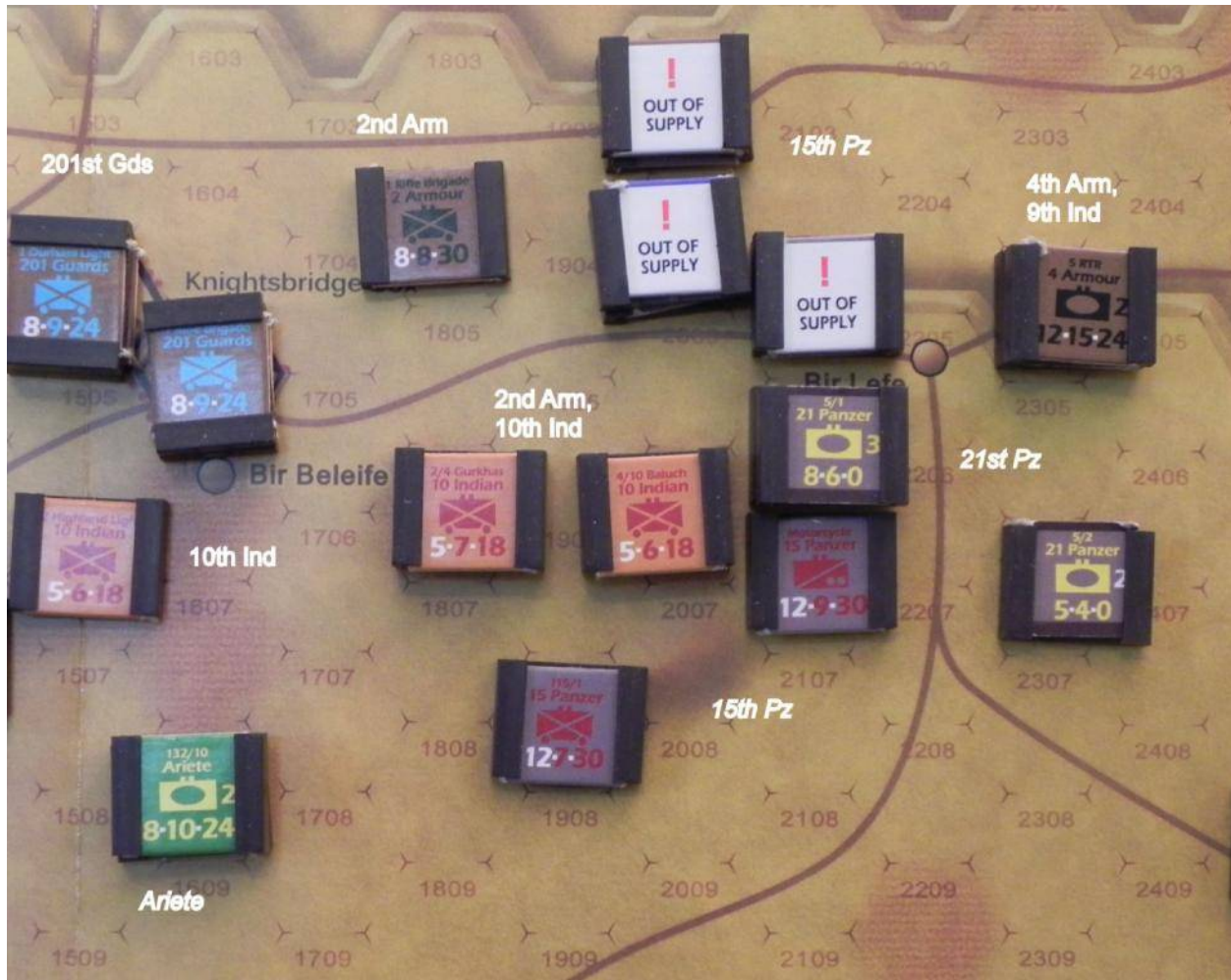

21st Panzer

The Allies draw 10th Indian. Since the units of that formation are in the positions where the Allies want them, they use the activation to bring on 9 Durham Light Infantry, to help screen El Adem from advances by *15th Panzer*.

The Axis draws Combat and then *15th / 21st Panzer*. This is about as good as they could have hoped for. *21st Panzer* draws in 5/2 from its flanking position, and the entire division attacks 3 Yeomanry (2nd Armour) and 4/10 Balauch (10th Indian). The odds are 3:1 +2 (heavy attack) +1 (Combat) -1 (rough terrain). The result is /*RD. The Allies take the loss with the infantry unit, while the armour retreats and is disrupted.

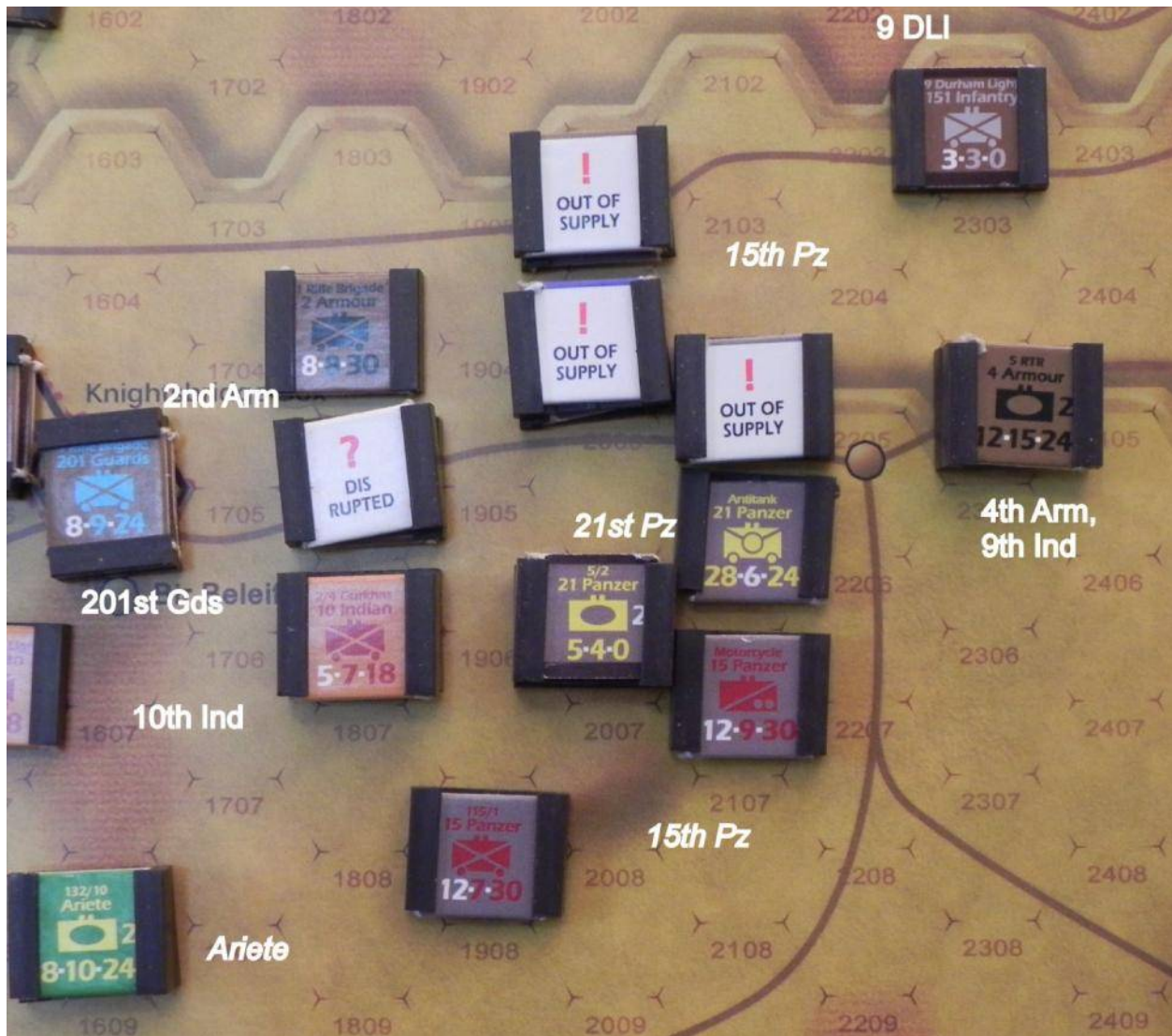

Second 21st Panzer activation

The Allies draw 1st Army Tank Brigade. They move two units of that formation across the minefields and back into the triangle, where they can threaten to again close the line of communications, if the Axis gets careless later.

The Axis draws Armor Replacement, Extra Move, Airstrike and *Ariete / Trieste*. The Airstrike has to be used right away. The axis attacks 3RTR (4th Armour), to discourage that formation from causing trouble on their eastern flank. However, the result is no effect. *Trieste* moves through the minefield breaches and takes up positions to provide security in the triangle, which will enable the *90th Light* units to redeploy.

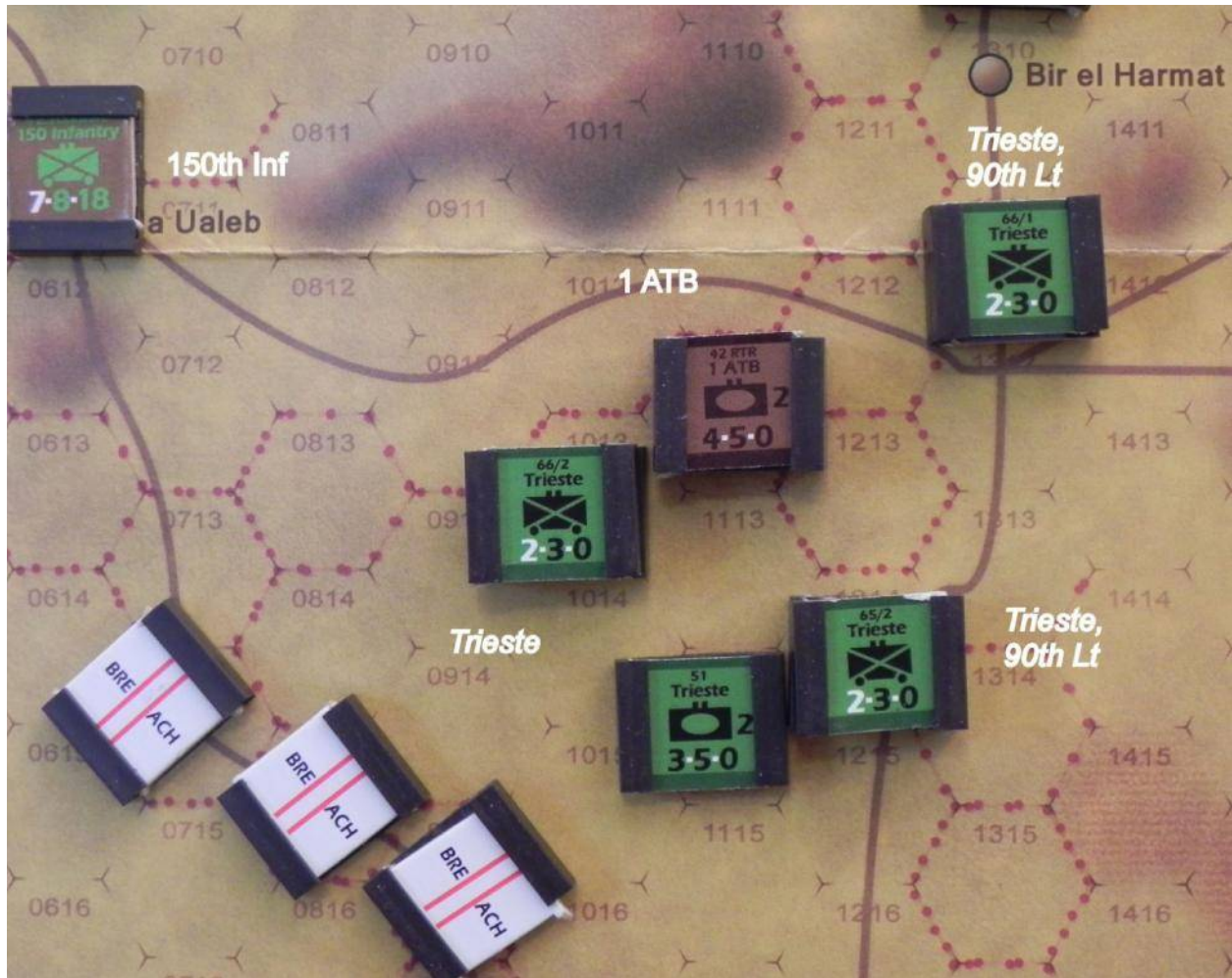

After 1st ATB and Trieste activations

The Allies, wondering what happened to their tactical chits, draw 2nd Armour. Those units aren't in a position to do very much, with one tank unit disrupted. Instead, the Allies activate 42 RTR of 1 ATB, which, supported by 44 RTR, launches a heavy attack against Trieste. The Italian infantry retreat and are disrupted but suffer no losses. The British tanks advance after combat, coming closer to squeezing shut the LoC. They have little to fear about counterattacks, since Trieste has only one tank unit that is even weaker than the ATB battalions.

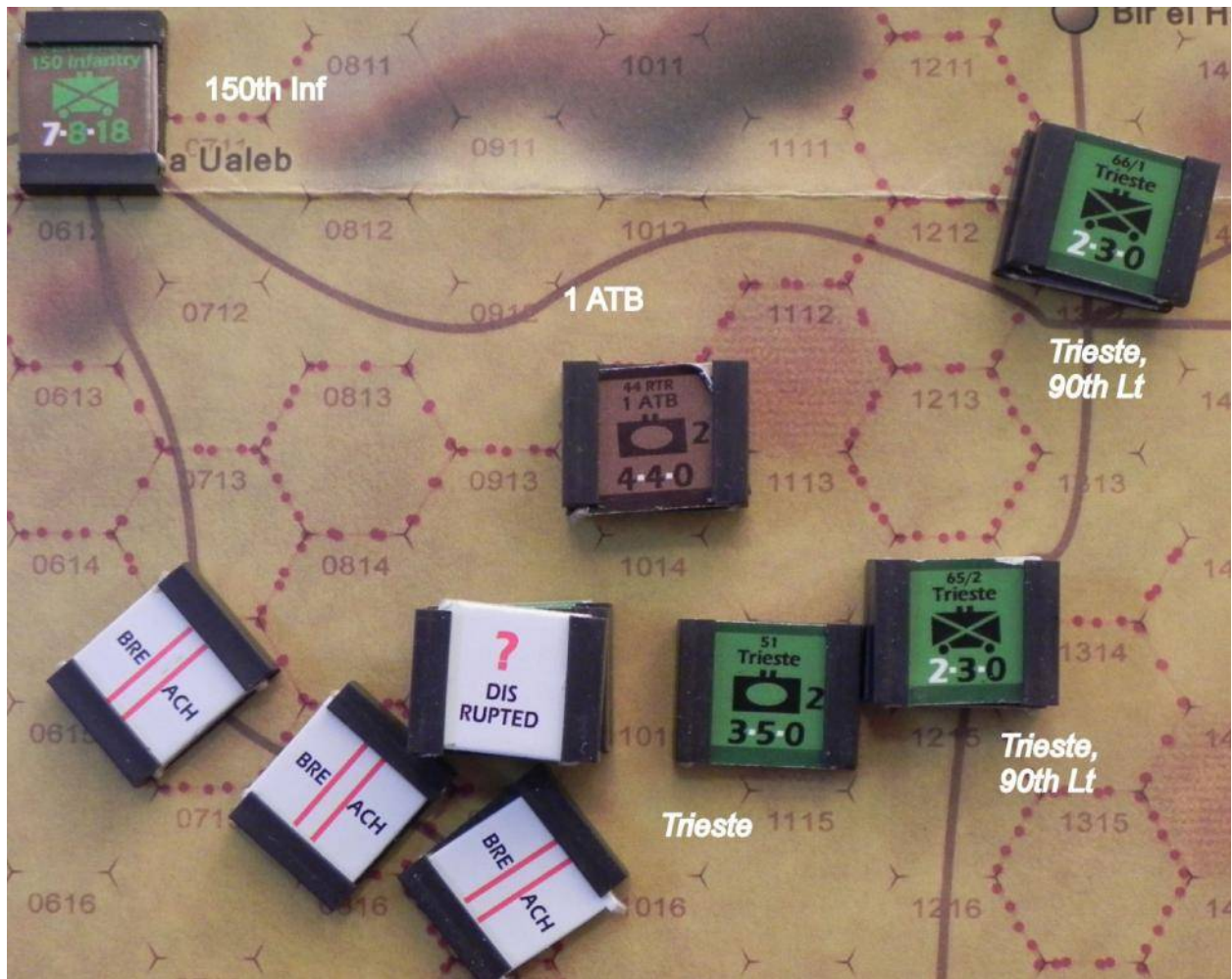

1 ATB second activation

The Axis draws *90th Light / Pavia – Brescia*. They move *90th Light* units out of the triangle and to the northeast, where they can provide flank security for the *Panzer* divisions. They also use Extra Move to activate *21st Panzer*'s recon unit, which moves adjacent to 9 Durham Light Infantry in hopes of setting up an attack later in the turn.

Gazala: The Cauldron

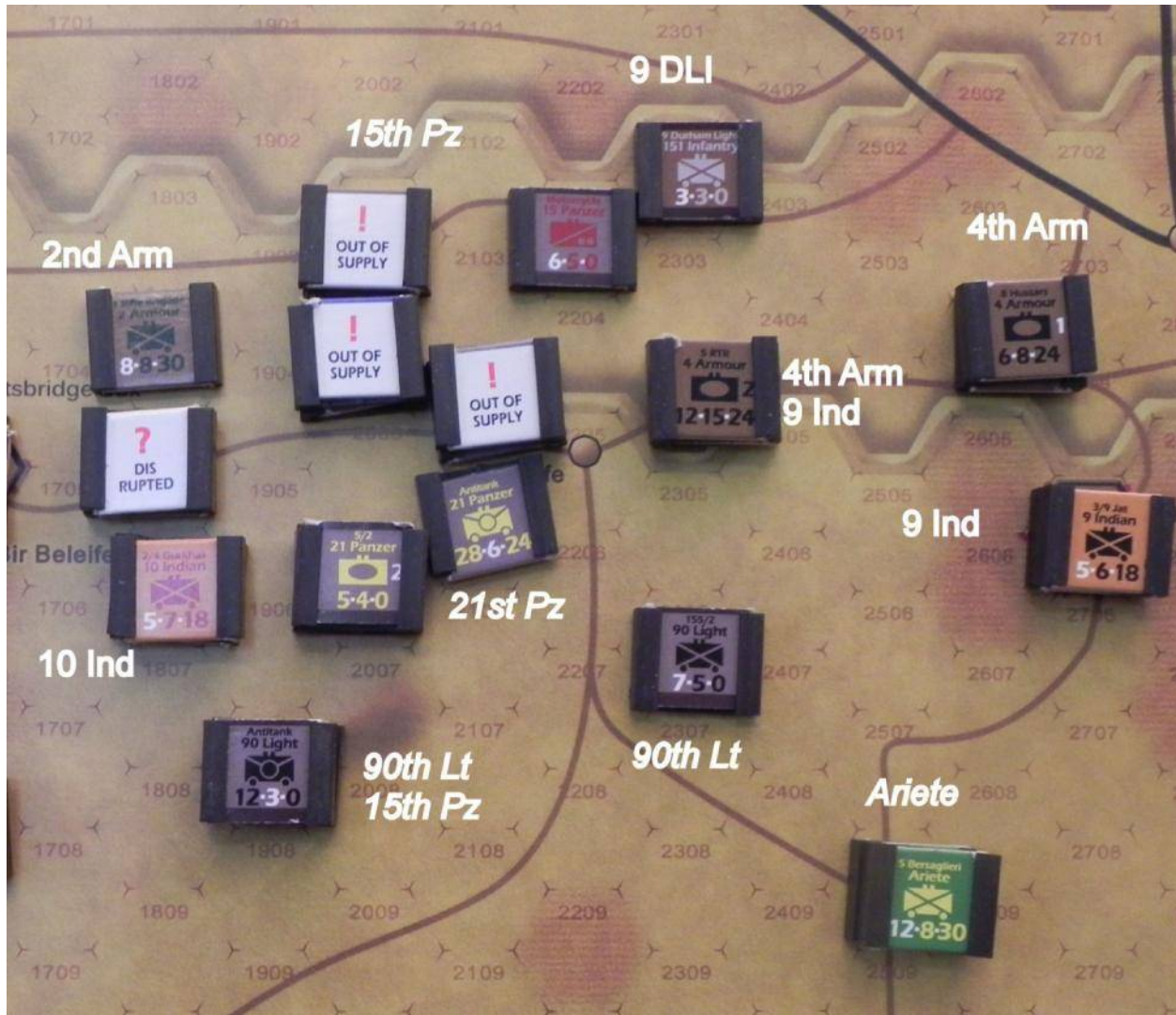

90th Light

The Allies draw 22nd Armour. They move the division to surround a stack of *Ariete*, to either put it out of supply or perhaps set up a heavy attack.

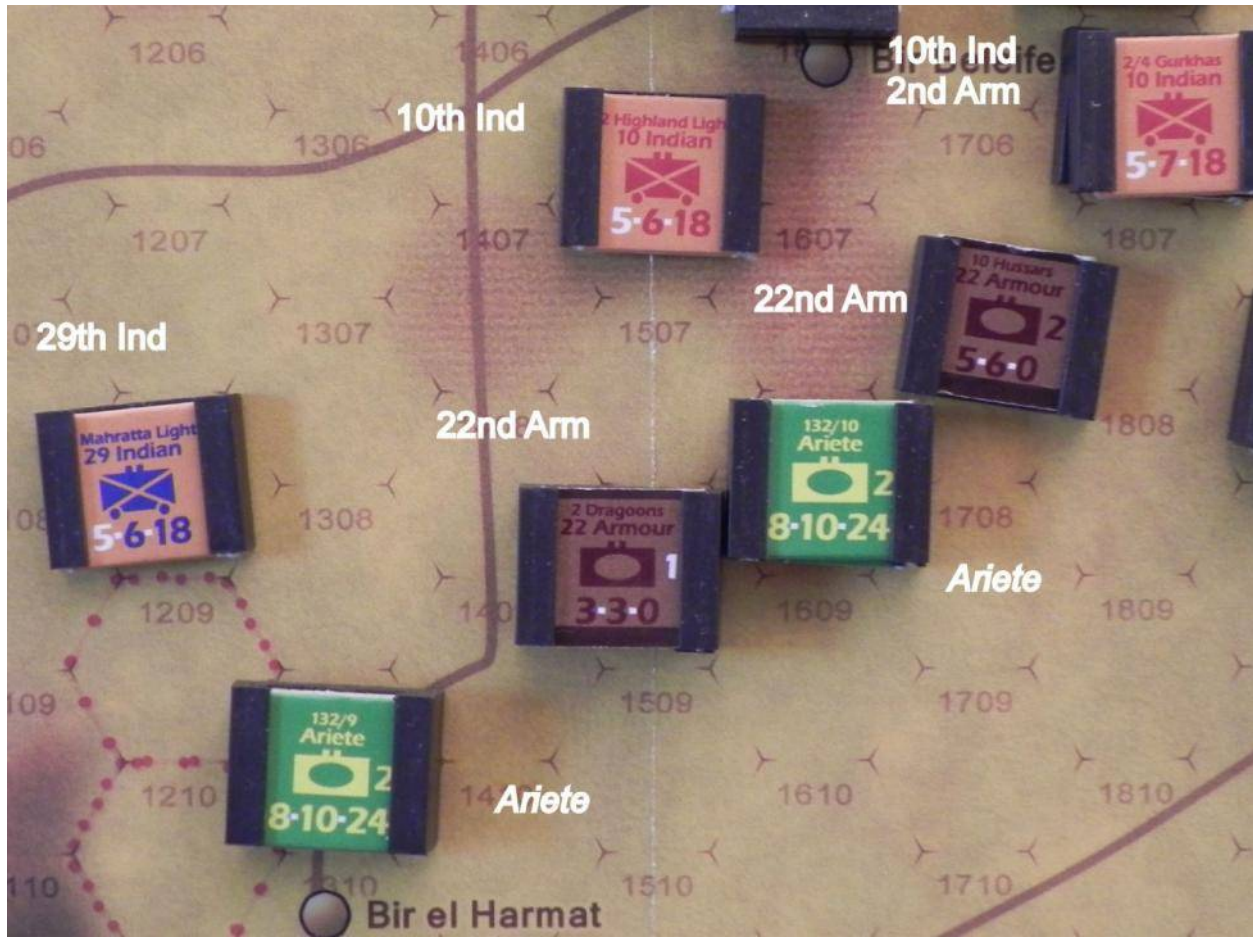

22nd Armour

For their last activation, the Axis draws *Ariete* / *Trieste*. This puts them in an excellent position to turn the tables on 22nd Armour. First they use their Armor Replacements to bring 5/2 *Panzer* up to full strength. Then *Ariete* pulls in its antitank unit and uses most of its armor to go after a stack of 22nd Armour. It's a 3:1 with +2 DRM, but they only succeed in disrupting the British. However, now the Brits are going to be out of supply next turn unless they can do something to fix it.

Gazala: The Cauldron

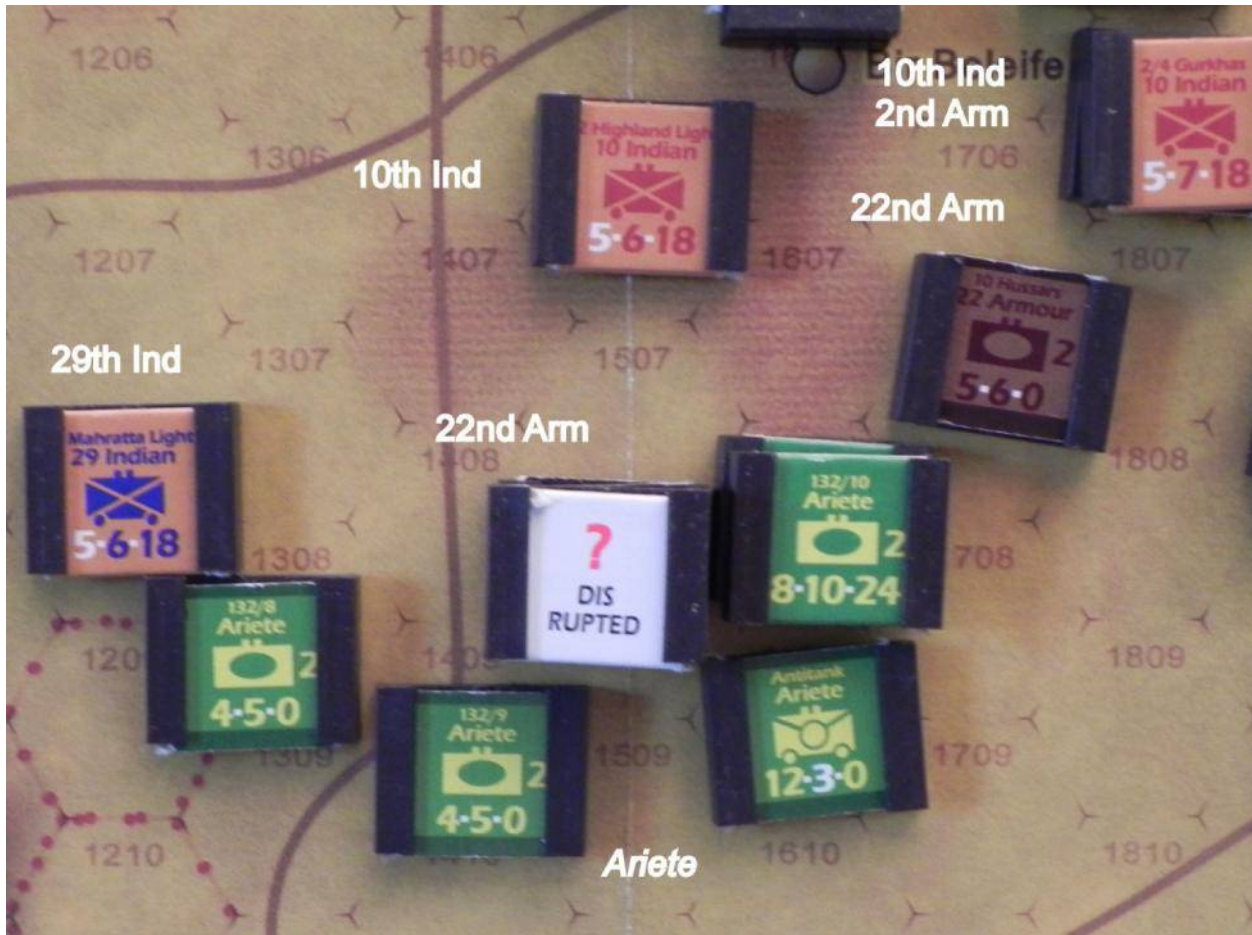

Ariete

The Allies draw 4th Armour. The reconstituted brigade launches a 5:1 attack against *15th Panzer*'s recon unit, destroying it.

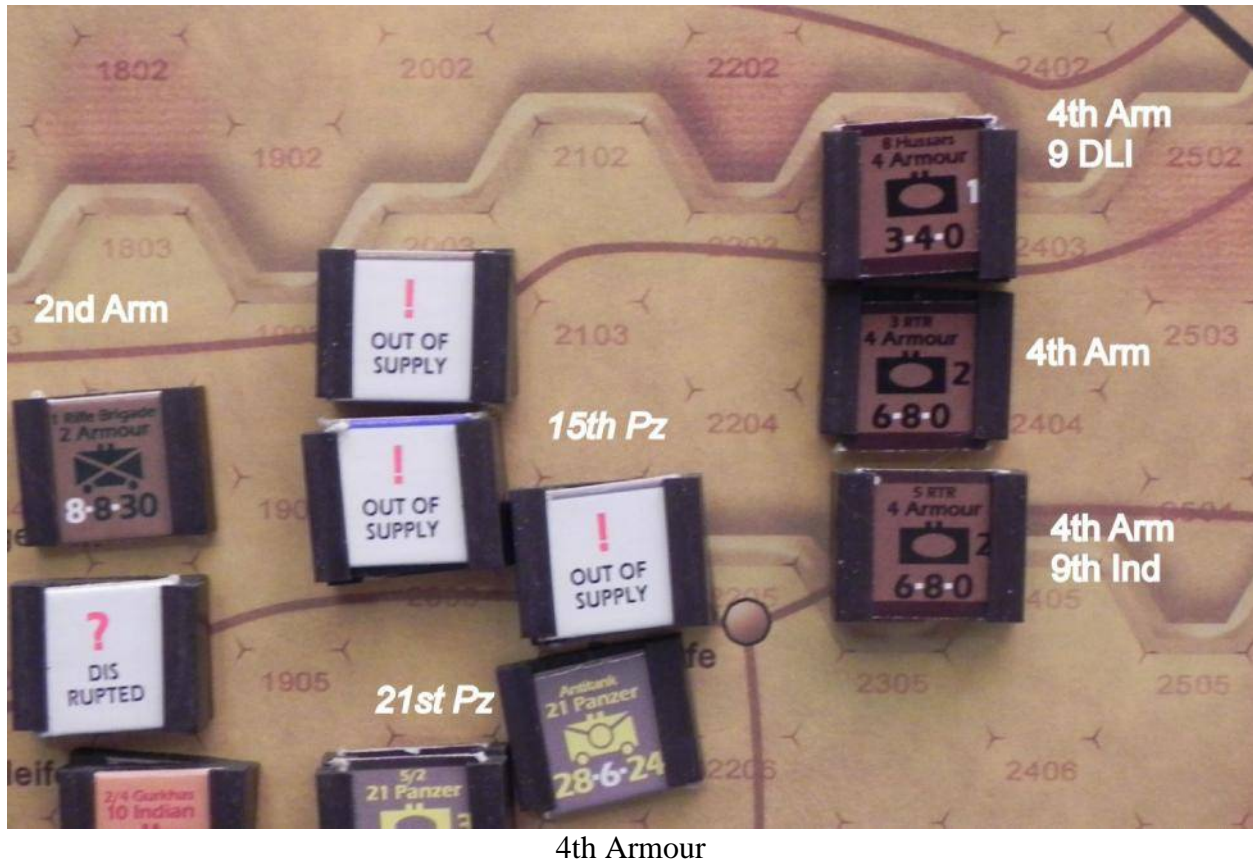

The Allies finally draw a tactical chit—and it's Sandstorm! Then they draw Airstrike, which is nullified by the sandstorm. Then they draw 9th Indian. Rather than activate that formation, they bring in the independent Cumberland motorized infantry battalion, which moves into line behind 22nd Armour, thereby establishing a supply line.

June 7-8

The Axis has 3 activations this turn, and the Allies have 1. All of the Allied chits are in the cup, including double move. The Axis have only one formation chit of each type, which means that only one panzer division will be able to activate.

There are no new reinforcements, but the Allies still have 32nd Army Tank Brigade off map.

There is no minefield completion, and the Axis chooses not to start any new breaches.

Gazala: The Cauldron

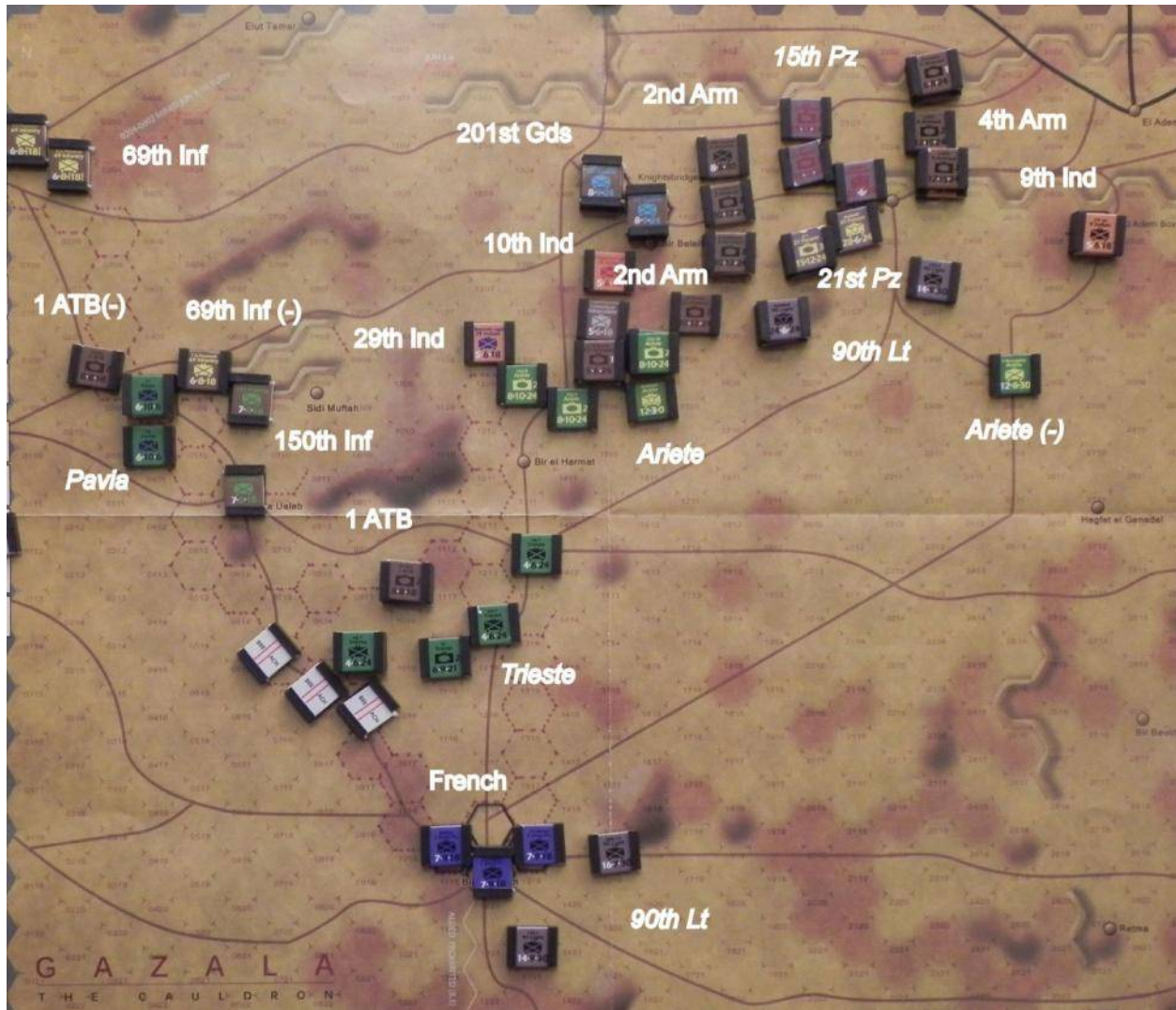

June 7-8 Start

The Allies get the initiative. They choose to let the Axis activate first.

The Axis draws *Ariete* / *Trieste*. First, *132/9 tank* launches a heavy attack against *22nd Armour*, supported by *132/10* and the divisional antitank battalion. The result is mutual step loss; the British take theirs by reducing *9th Lancers*. Next, *132/8* moves into position and conducts a medium attack against the same stack, supported by *132/9* and the antitank unit, but the result is no effect. The Italians consider attacking yet again with *132/10*, but that would mean also attacking both *Cumberland Infantry* and *10th Hussars*. The activation ends with no ground gained or lost.

The Allies draw *10th Indian*. They decide to activate *3rd Yeomanry* (*2nd Armour*) so that they can stack it with *1 Rifle Brigade*.

The Axis draw *Combat* and *90th Light* / *Pavia* since those two formations are about where the Axis wants them, they instead reactivate *Ariete's 132/8* for yet another attack on *22nd Armour*. But their die rolling continues to be bad, and the result is another exchange. The Allies absorb

the loss by eliminating 2 Dragoons. It has cost the Italians quite a bit, but the British are reduced to a single step of armour in that hex, and it is trapped by Italian ZoCs. One stack of *Ariete* is also trapped by British ZoCs. The two formations are thus stuck together, but the Italians have more strength left.

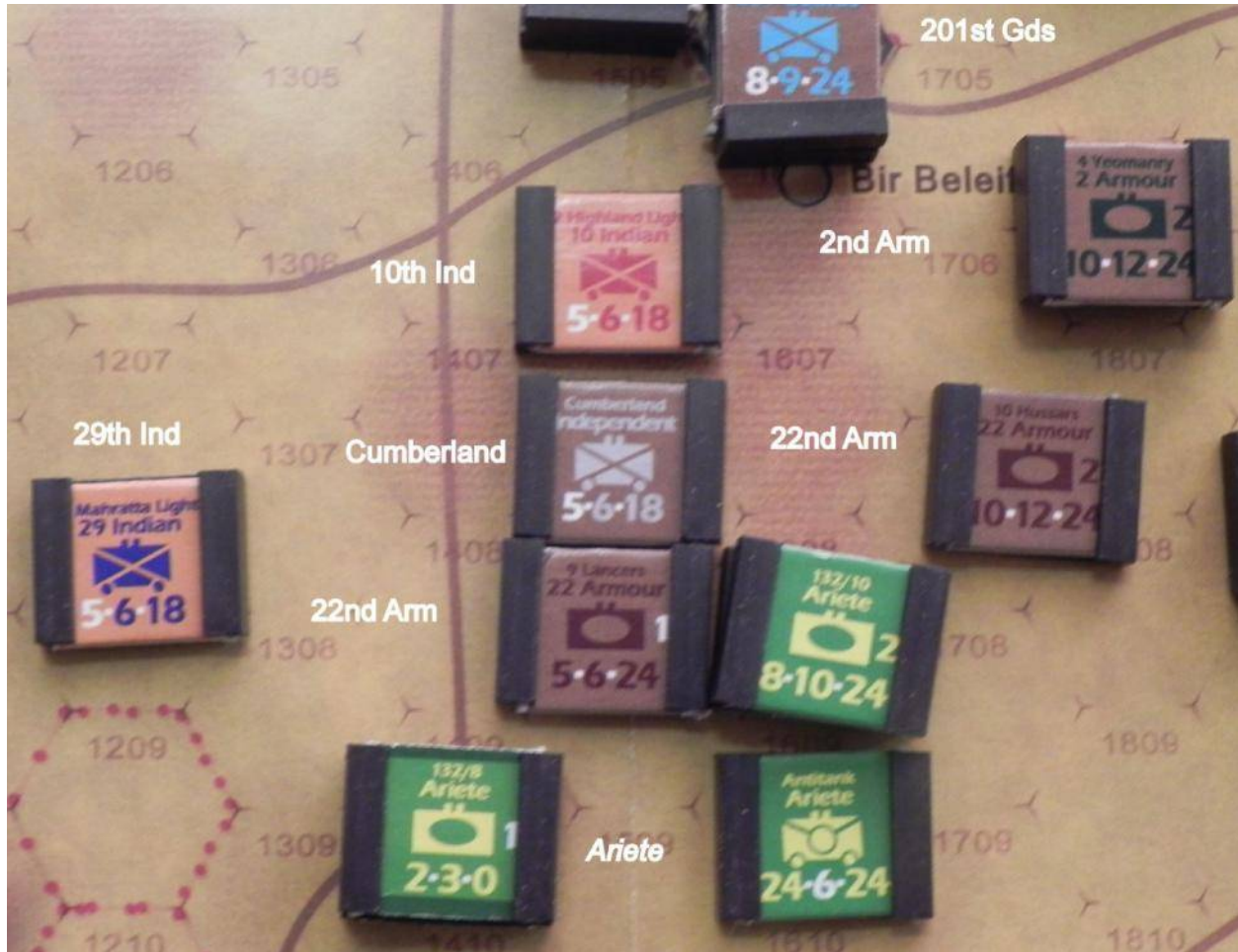

After first three activations

It's kitchen sink time, as the Axis draw Sandstorm, Antitank, Airstrike, Armor Replacement, Extra Move, and *15th / 21st Panzer*. Yet again, Sandstorm precludes the use of Airstrike. Nor can they use the armor replacements. The only depleted tank units are the Italians, and they are adjacent to the British. Of course, the sandstorm also limits the maneuvering of the activated formation. *15th Panzer* moves its infantry and antitank units to keep 4th Armour off its tail while the tank units more into contact with 2nd Armour. Because of the sandstorm, they don't have enough movement points to launch even a light attack, but they will be ready next turn if their luck changes. The British units are too weak to launch a counterattack against two German tank battalions on their unactivated sides.

Gazala: The Cauldron

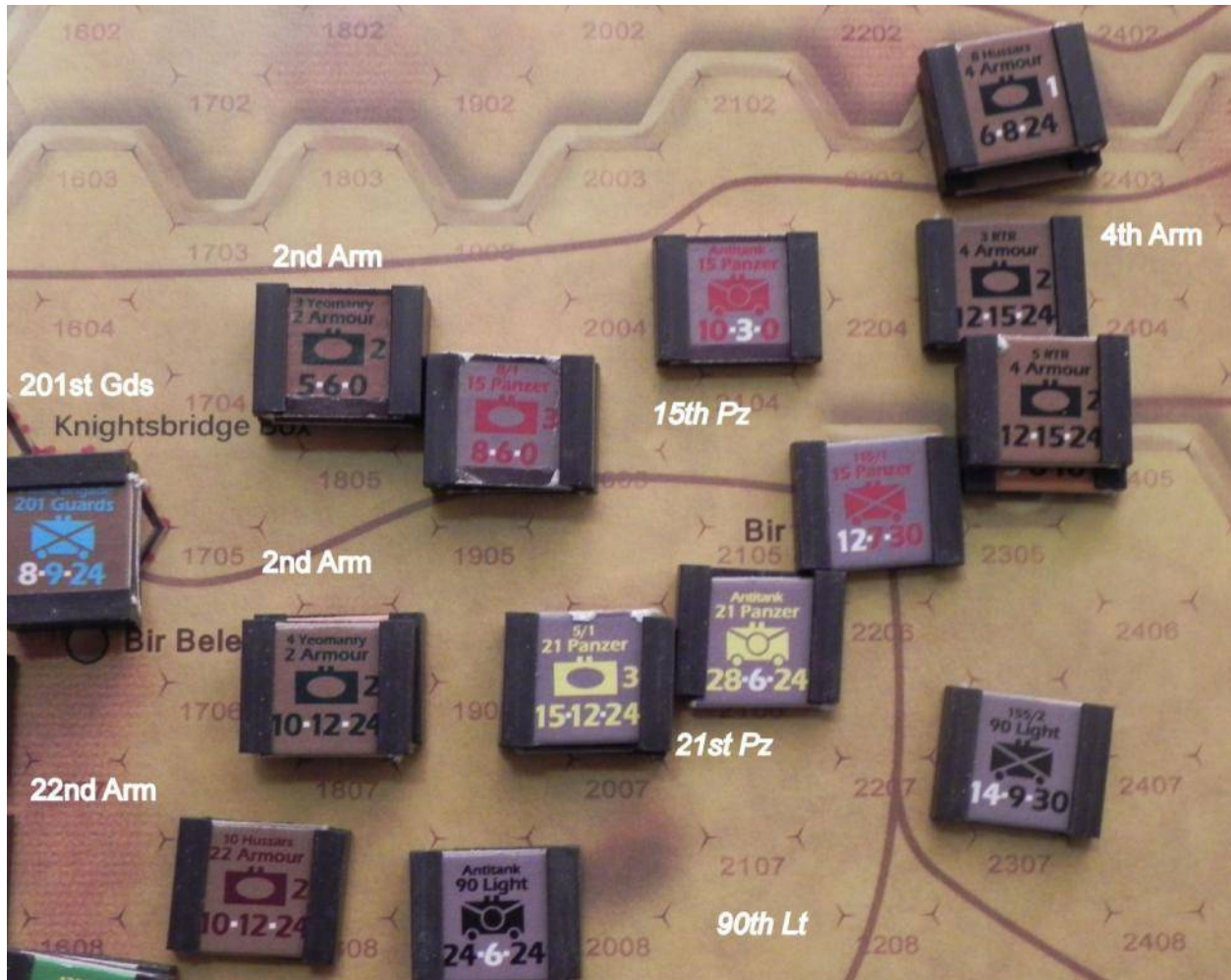

15th Panzer

June 9-10

The Axis has 4 activations, and the Allies have 3. The Axis gets both of their panzer activation chits.

The Allies get 1 armour replacement point, which they use to place 22 RTR of 22nd Armour on the map, at depleted strength. The Allies still have 32 ATB waiting to enter. The Axis gets the two regiments of *Brescia Division*.

There is no activity in the minefield phase.

The Axis gets the initiative.

Gazala: The Cauldron

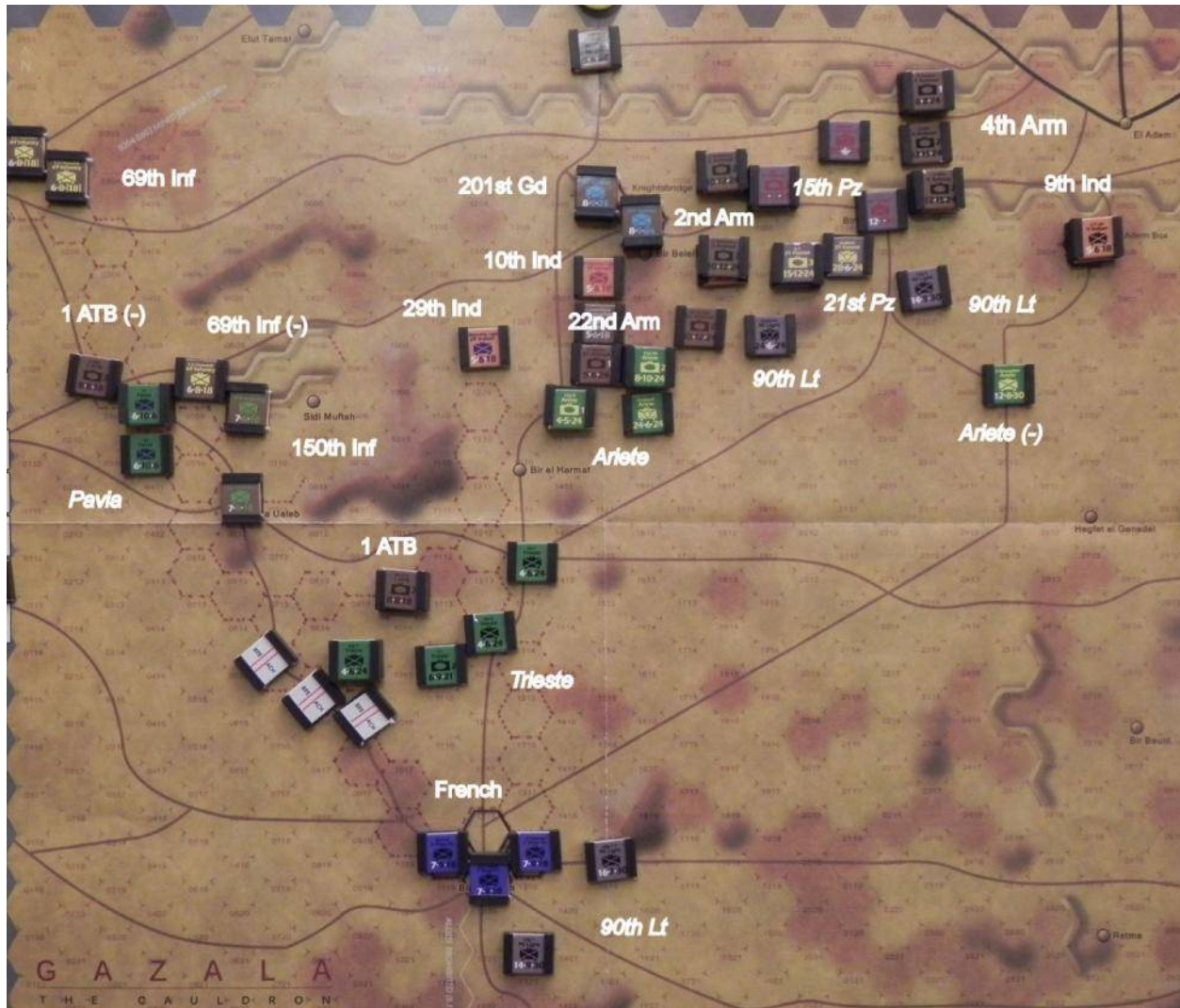

June 9-10 Start

The Axis draws *15th / 21st Panzer*. They activate *15th Panzer* to execute the attack they set up in the previous turn. The result is that the British take a step loss from 3 Yeomanry and have to retreat. *8/2 Panzer* advances after combat, while *8/1 Panzer* moves southwest to threaten a collection of Allied units southeast of the Knightsbridge Box.

Gazala: The Cauldron

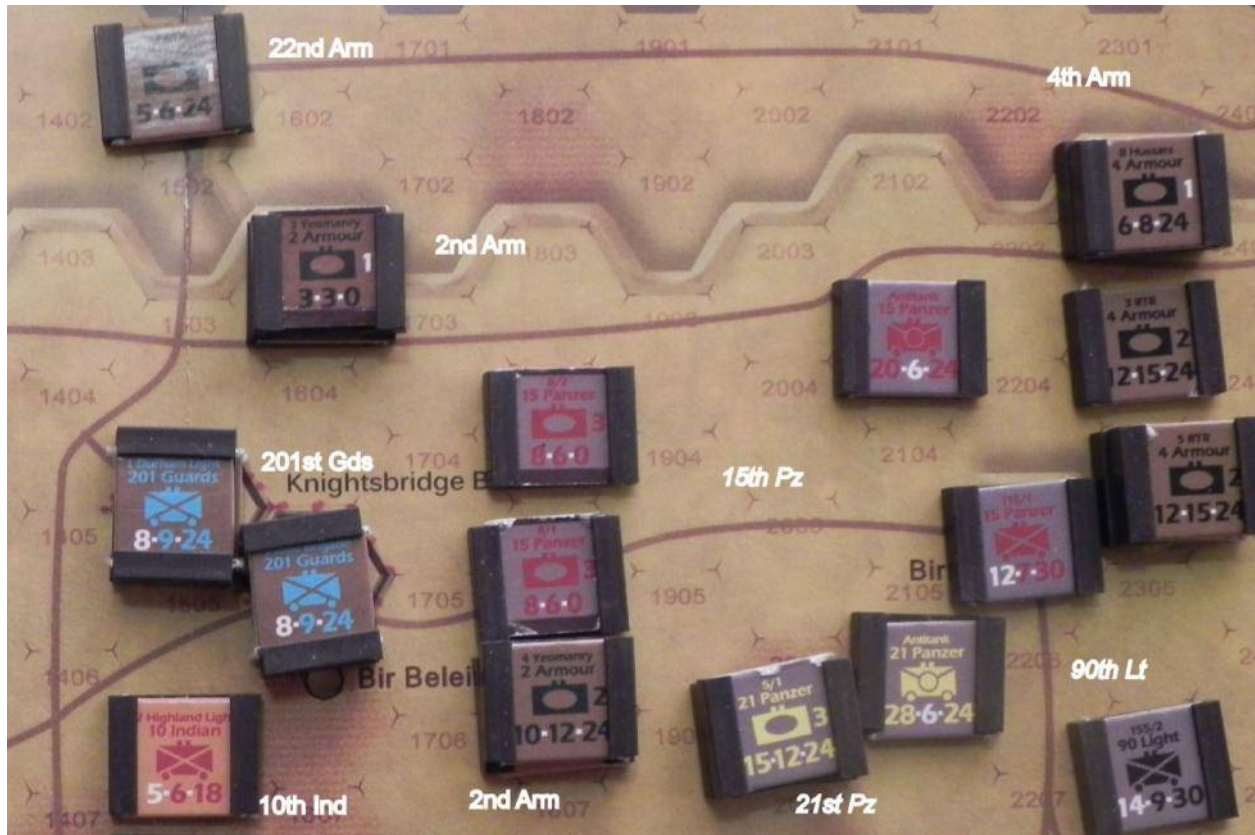

15th Panzer

The Allies draw 22nd Armour. Their main concern is extricating the remains of 9 Lancers from their trap. They move 10 Hussars around to a position southeast of the Lancers and attack the two depleted *Ariete* tank units. It's only a 3:2 attack, but they roll well, and the Italians retreat and are disrupted. Then 9 Lancers moves to join 10 Hussars in the same hex.

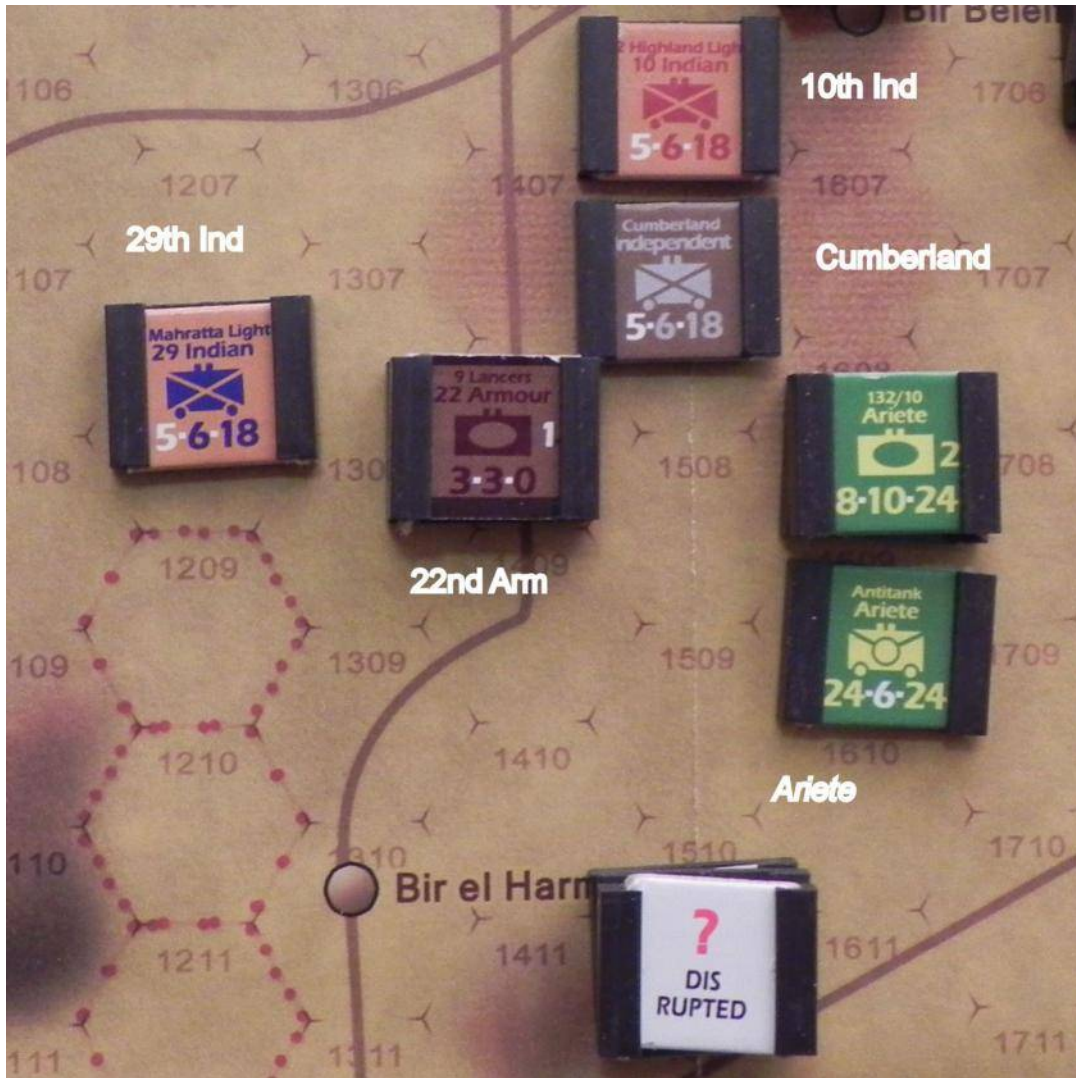

22nd Armour

The Axis draws Sandstorm, Armor Replacement, Antitank, and Ariete / Trieste. They activate Ariete. Despite the sandstorm, 132/10 tank launches an attack against Cumberland Independent, supported by 12 Bersaglieri. It's a 3:1, -2 for a light attack. The result is an exchange, which reduces the Italian unit and eliminates the British. 132/10 advances after combat while the division's antitank unit circles around the 22nd Armour stack. These moves surround the stack yet again. 12 Bersaglieri moves a bit to the northeast in order to provide better flank security for the tanks.

Gazala: The Cauldron

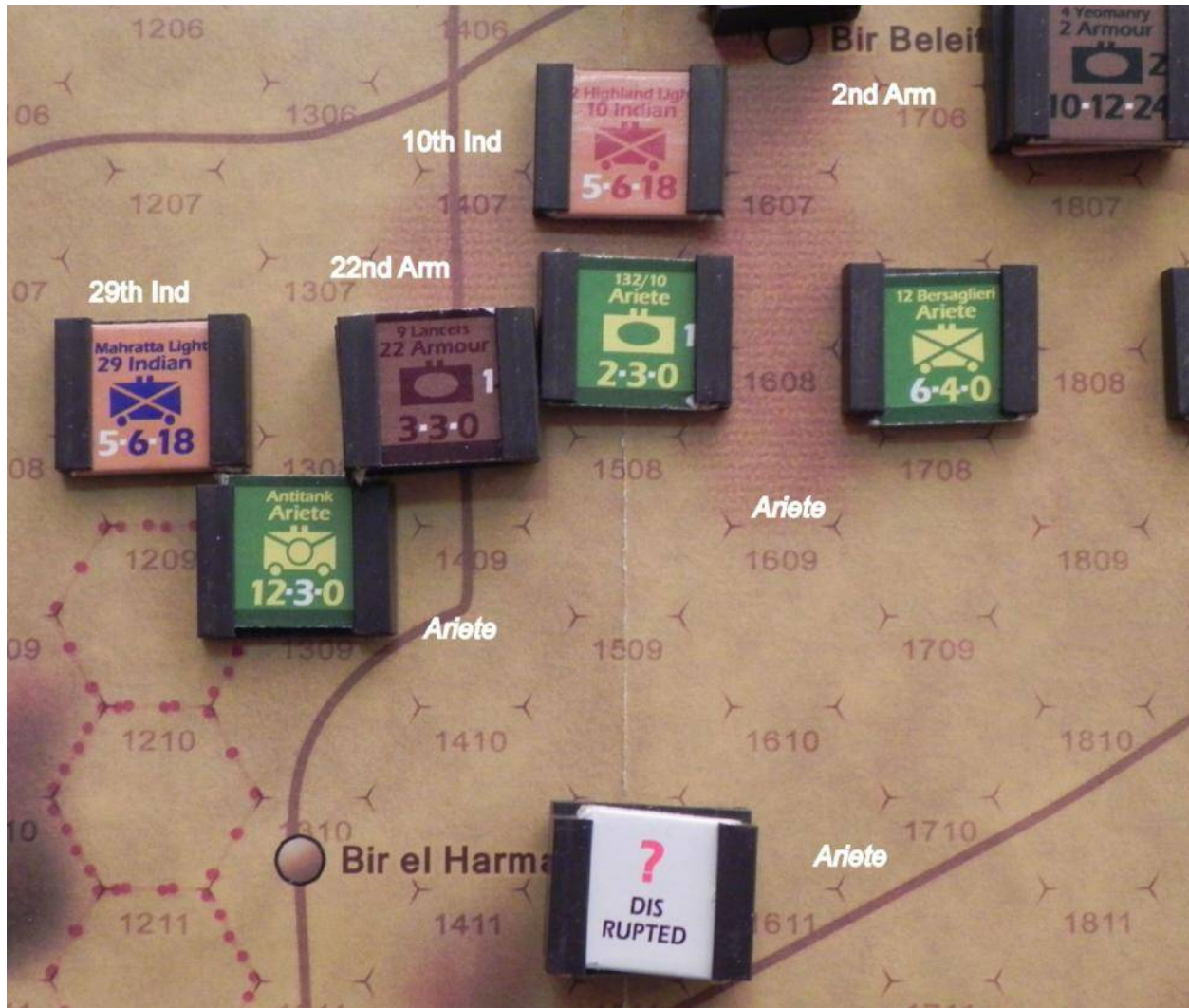

Ariete

The Allies draw 32 Army Tank Brigade. 4 RTR comes right down the road and conducts a hasty attack against 132/10, aided by 22 Armour, which disrupts the Italians. Then 7 RTR repeats the attack, and 132/10 finally succumbs.

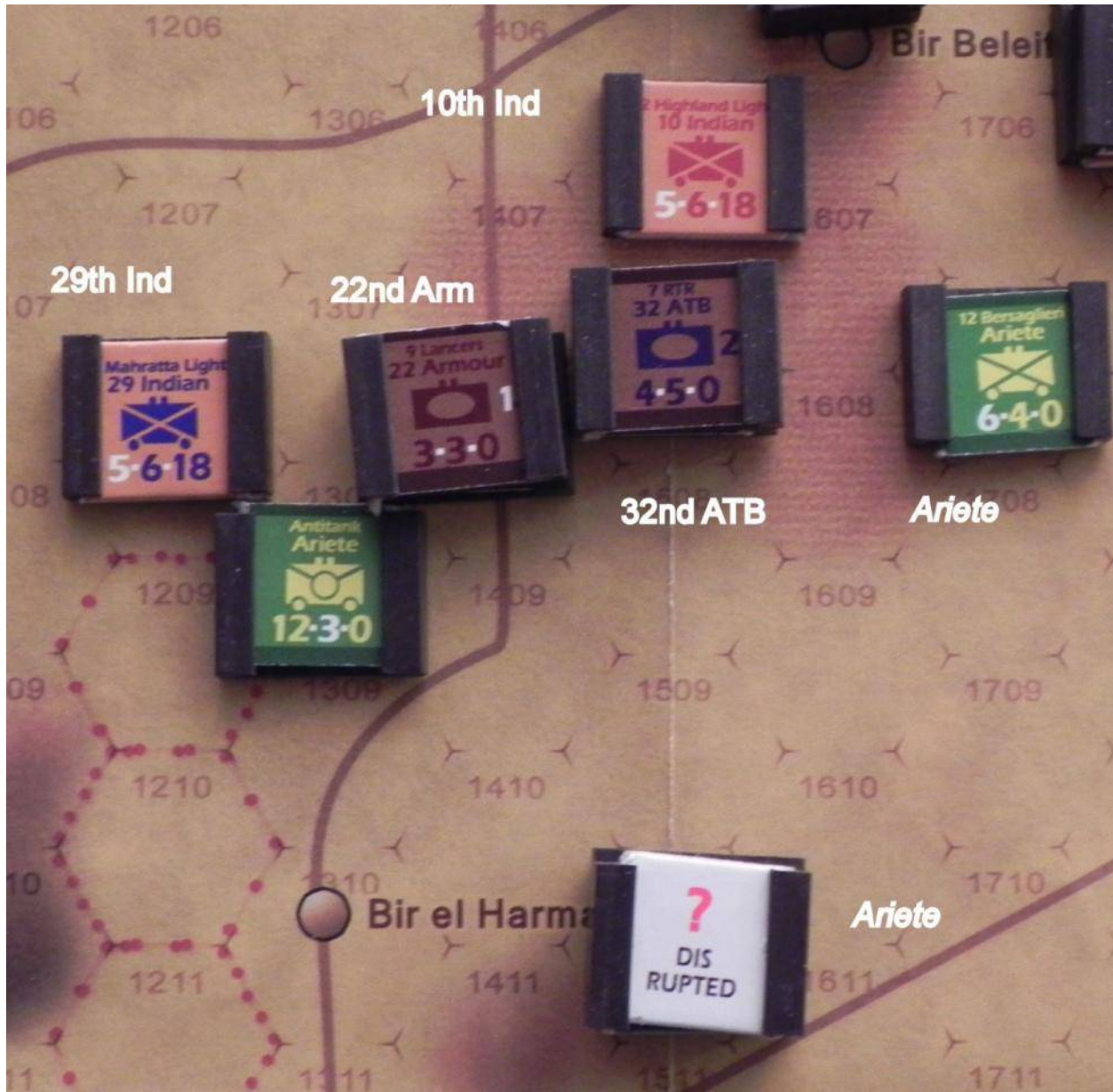

32nd Army Tank Brigade

The Axis draws *90th Light / Pavia – Brescia*. They bring in *Brescia*, which takes up the positions occupied by *90th Light* near Bir Hacheim so that formation can redeploy. They also start marching *Pavia* south to join them, in hopes of mounting an attack on the French.

Gazala: The Cauldron



Pavia - Brescia

The Allies draw Sandstorm, Withdraw / Attack, and 2nd Armour. Not a good combination. 4 Yeomanry is currently surrounded by enemy ZoCs and needs to break out. The Allies bring the other two (depleted) armour battalions forward, and 4 Yeomanry attacks with their support. The Axis plays their Antitank chit. It works out about as badly as it could for the Allies: RD/. 8 Hussars is eliminated by Antitank. 4 Yeomanry is disrupted and then loses a step while retreating through the enemy ZoC. 3 Yeomanry is disrupted and retreats. The only good things to say are that the remains of the brigade is no longer surrounded, and the attack satisfies the Withdraw / Attack requirement.

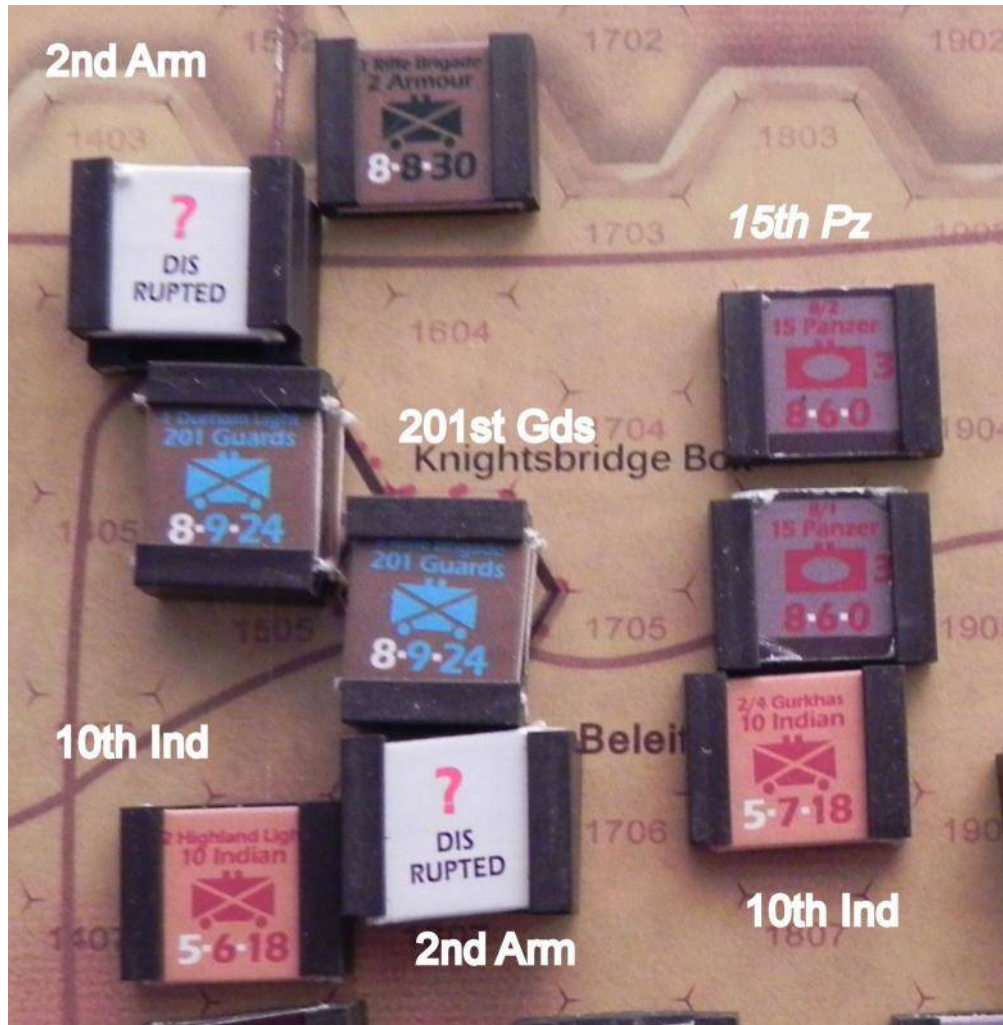

2nd Armour

The Axis draws Extra Move, Airstrike, and *15th / 21st Panzer*. They first use Armor Replacement to bring *Ariete's 132/9* back to full strength. They use the airstrike against *2/3 Gurkhas* of *10th Indian*, disrupting it. They use Extra Move to move *288 / 1-2 of 90th Light* to a position where it cuts off the supply line to the French holding *Bir Hacheim*. Then *5/1 Panzer* of *21st Panzer* moves forward and attacks *4/5 Gurkhas*, supported by *8/1 Panzer* of *15th Panzer*. The odds are 3:1, +2 for disruption and -1 for terrain. Surprisingly, the result is no effect. *8/1* keeps moving, ending its activation adjacent to *4 Yeomanry*. It is joined there by *5/2 Panzer*, which attacks both *4 Yeomanry* and *5/4 Gurkha*, supported by *8/1* and *5/1*. The odds and modifiers are just the same, but this time the outcome is /*RD. The Gurkhas are eliminated and *4 Yeomanry* retreats again. *21st Panzer's* antitank unit moves to plug the gap left by the retreat of *Ariete's* tank units.

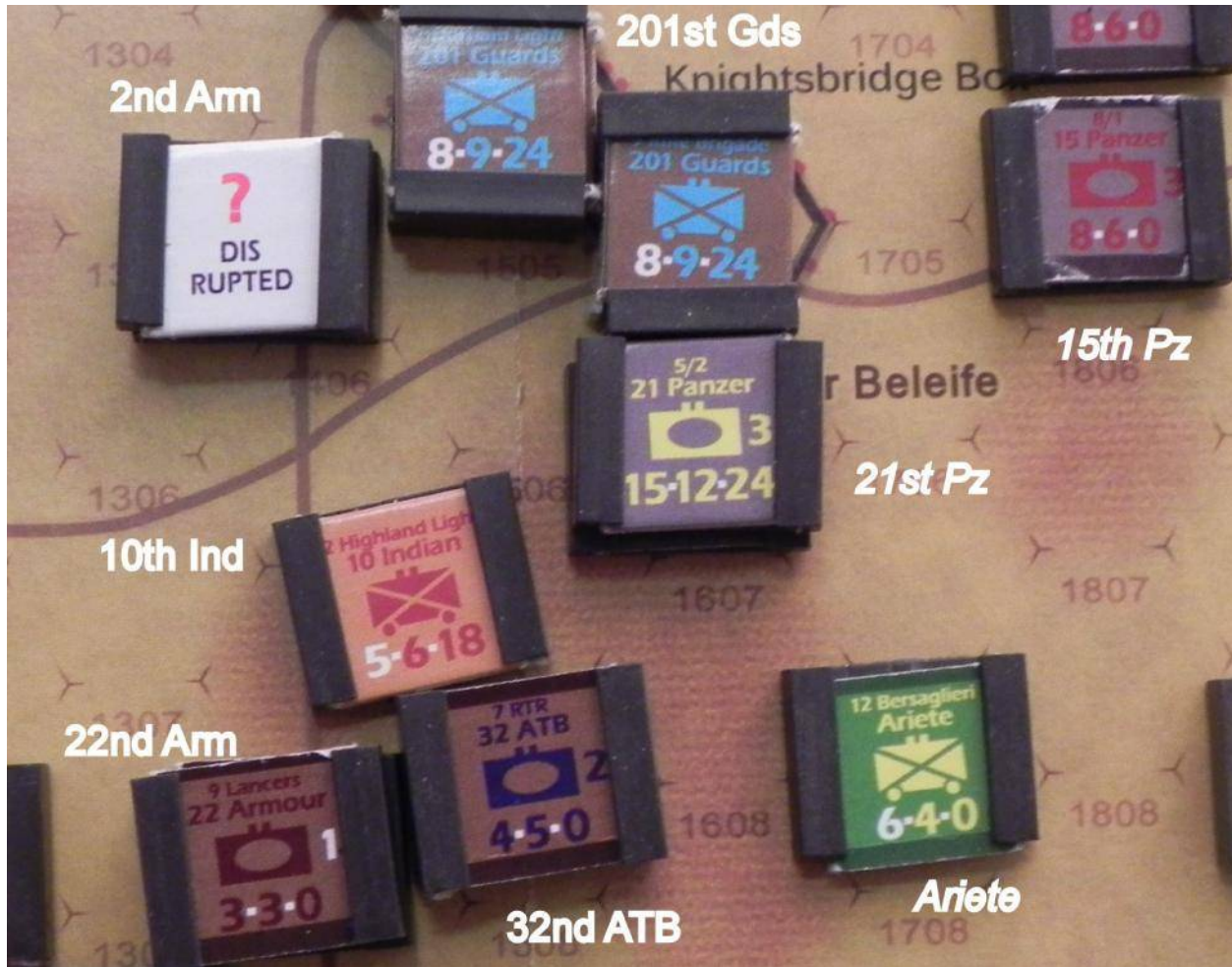

21st Panzer

June 11-12

Both sides get 5 activations. The Axis now has 3 chits for its panzer divisions and 2 for *Ariete* / *Trieste*. The Allies lose the chits for 9th and 10 Indian (probably just as well).

No reinforcements for the rest of the game.

The French units are out of supply.

288/1-2 of *90th Light* starts to open a minefield on the eastern side of the triangle, in order to provide another route for the LoC.

Gazala: The Cauldron

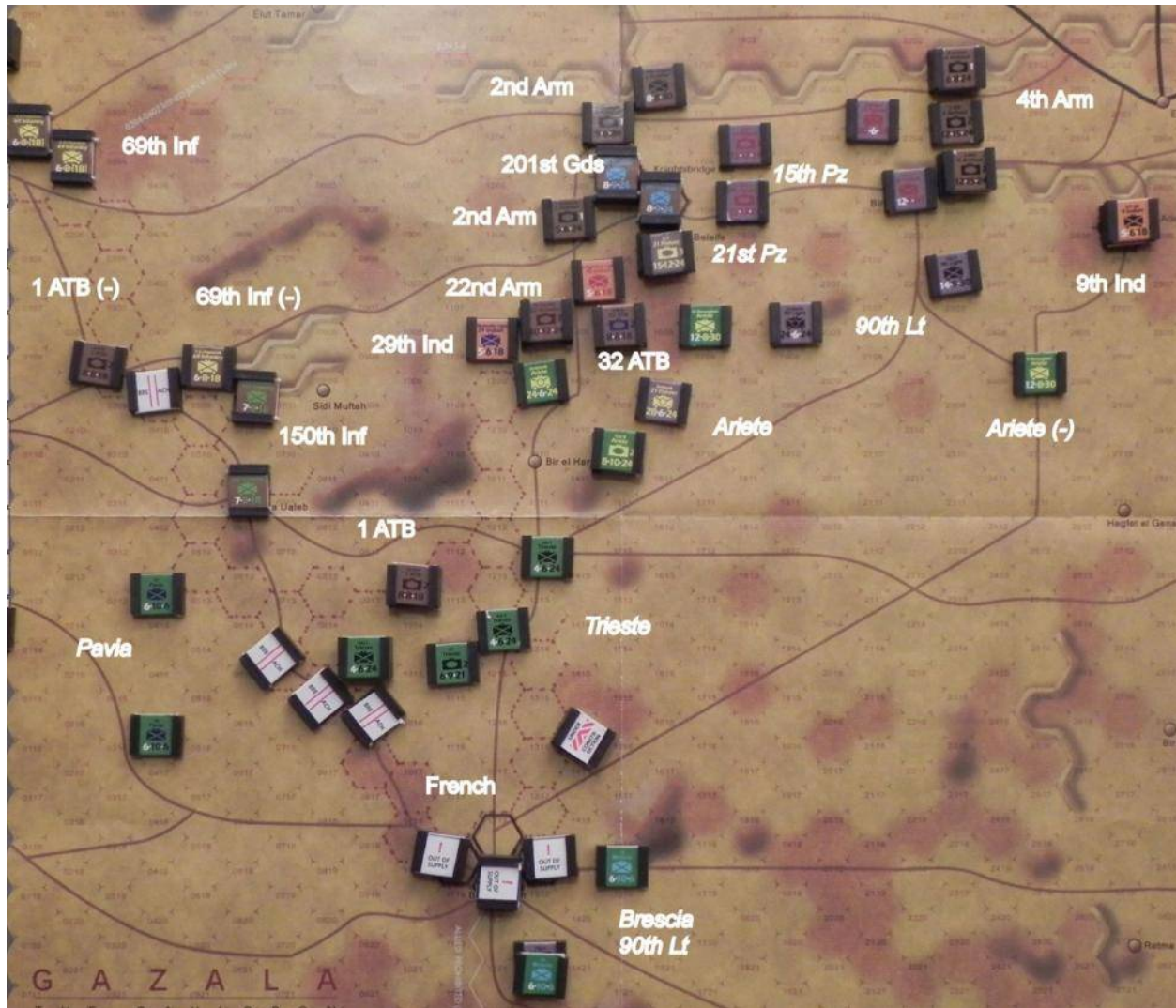

June 11-12, end of minefield phase

The Allies have the initiative. They draw Armour Replacement and 4th Armour. This brigade is sitting between the escarpments near El Adem, where the Axis is inviting them to bang their tanks against the 88s of their antitank and infantry units. However, they decline the offer. Instead, they leave their own infantry to keep watch and circle around on the roads to take up a position in reserve behind the western area, where 2nd and 22nd Armour are getting ground to bits.

Gazala: The Cauldron

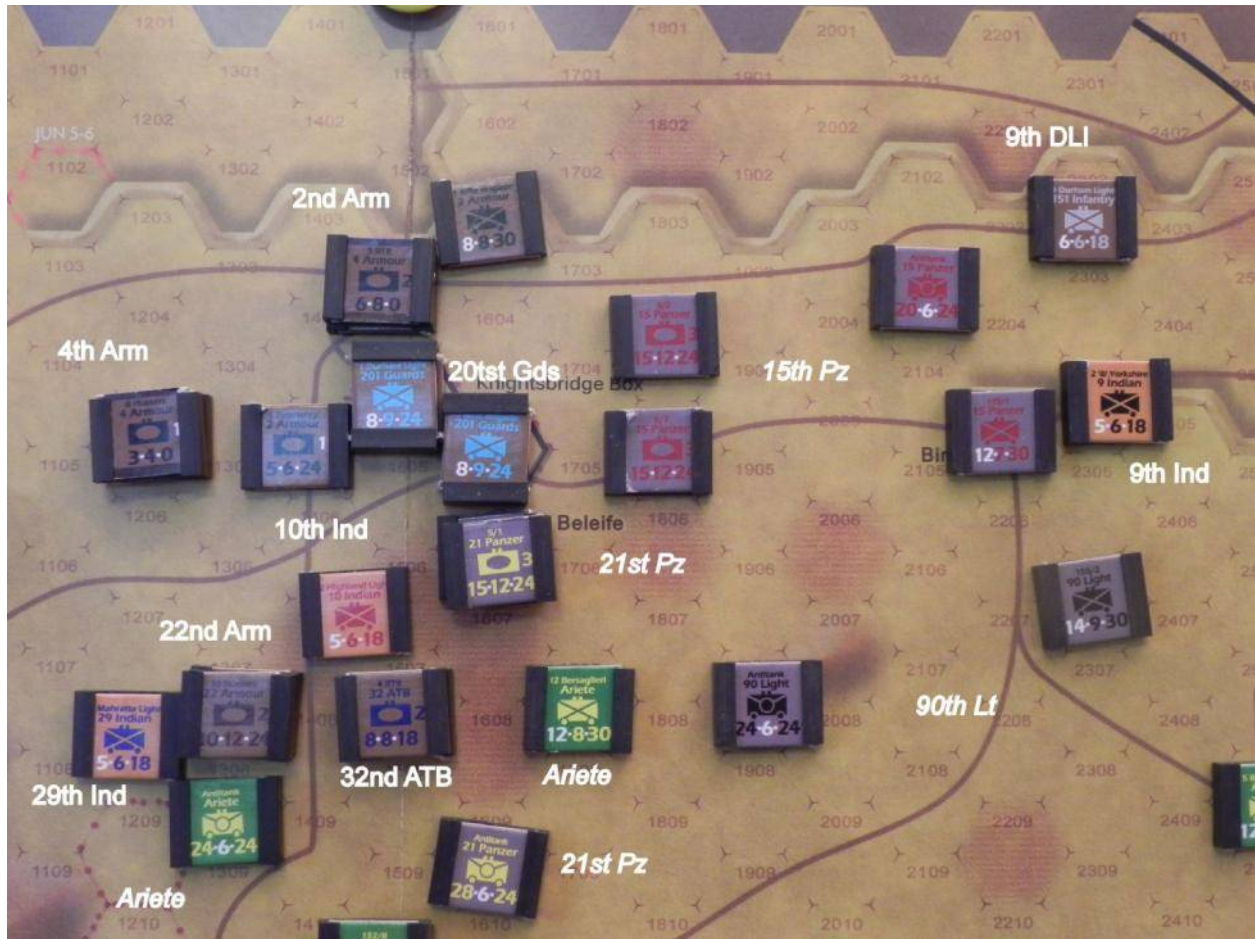

4th Armour

The Axis draws *Ariete* / *Trieste*. *Trieste* is still occupied with protecting the triangle from an opportune jab by 1 ATB. *Ariete* is pretty battered at this point. It moves back into line, in the hopes of getting to attack later in the turn, if its other activation chit comes up.

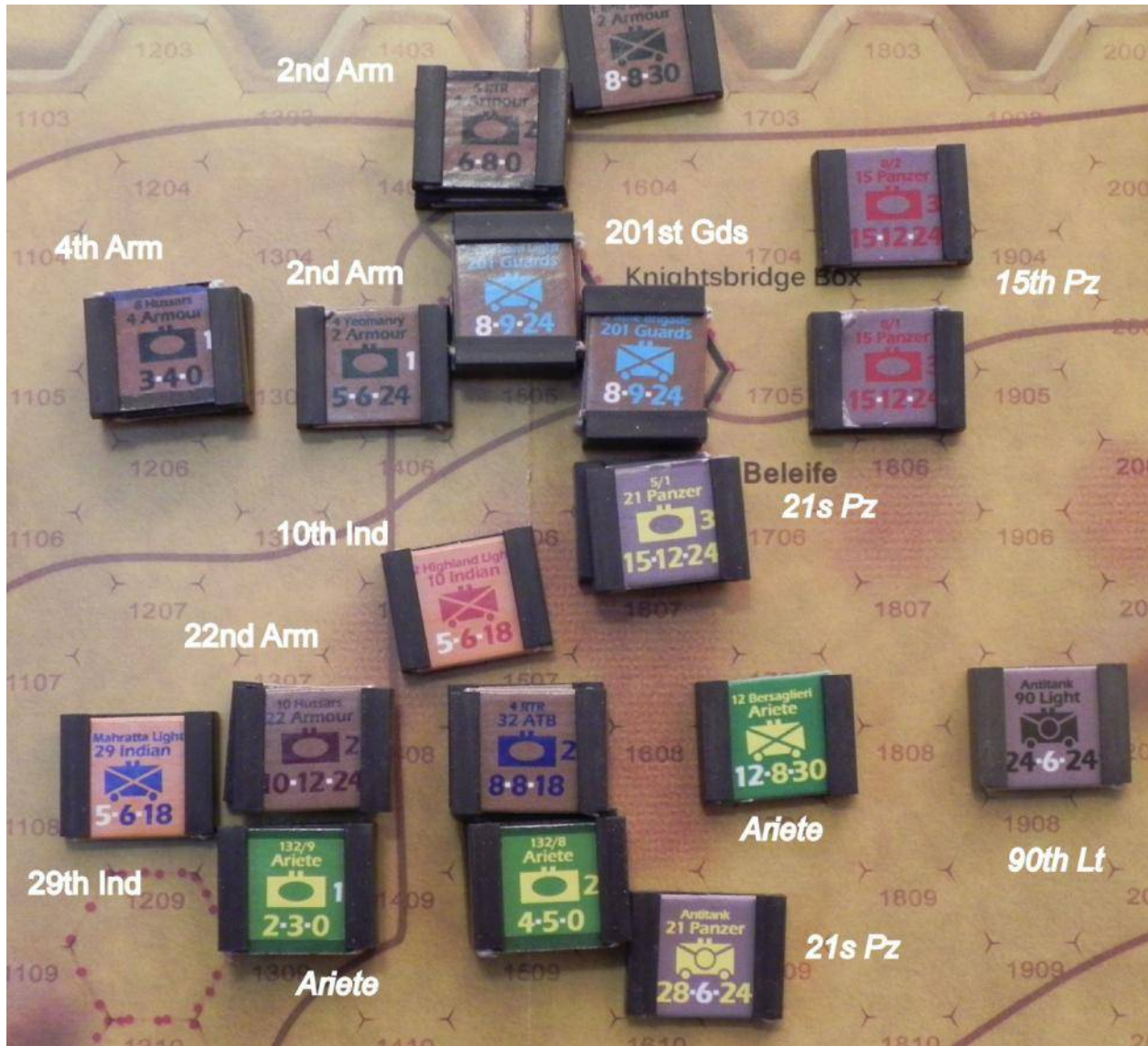

Ariete

The Allies draw Combat and 22nd Armour. 9 Lancers, supported by 10 Hussars, launches a heavy attack against *Ariete*, which has so obligingly moved adjacent to it, It's a 2:1 attack, +2 for heavy attack. The result is no effect. 10 Hussars then takes the lead and launches another attack, which has a much more favorable result: /*RD. The Axis eliminates 132/9 tank, while 5 *Bersaglierli* retreats, disrupted. The British units decline to advance, lest they be cut off by 21st *Panzer* advances later in the turn.

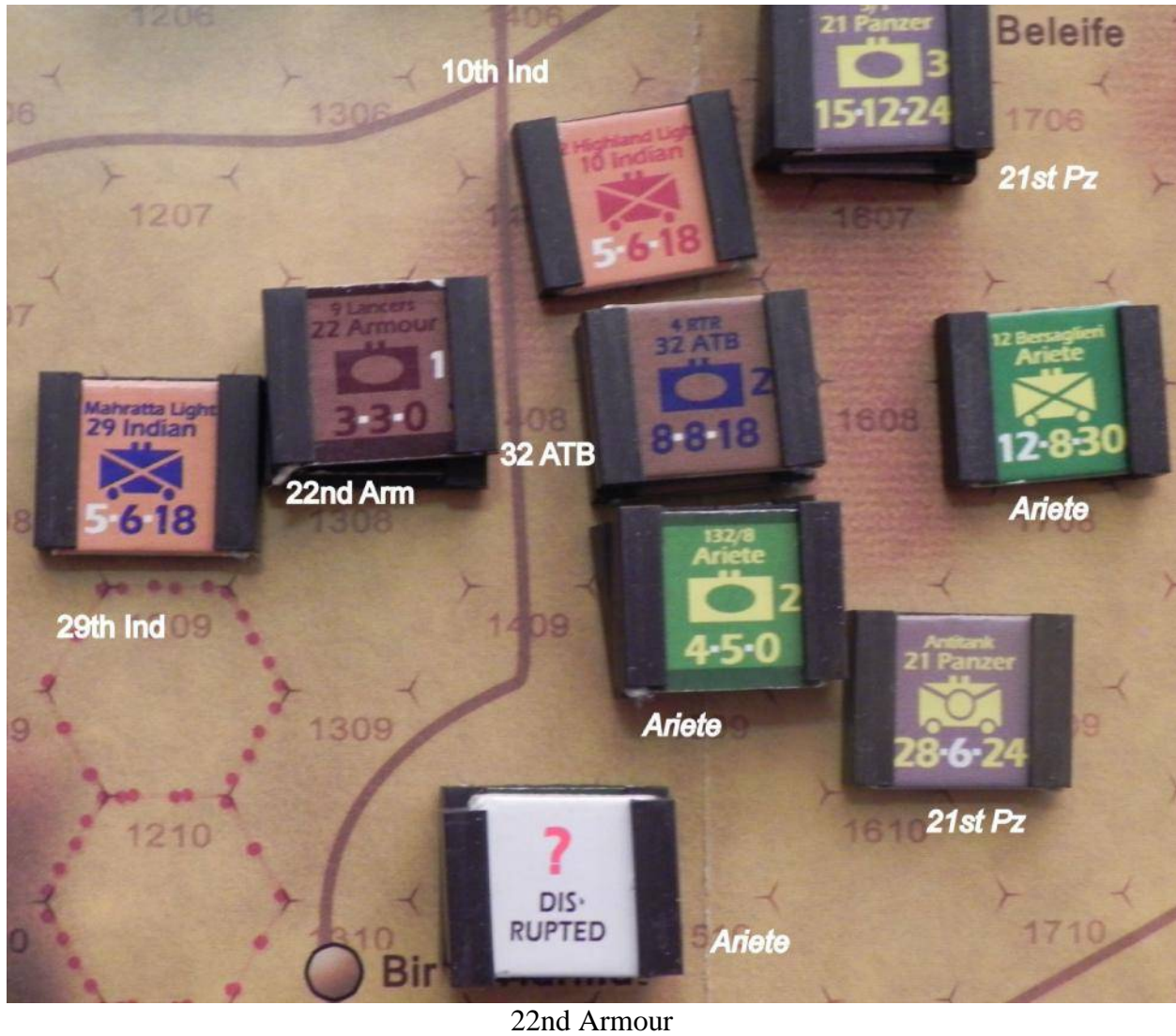

The Axis draws Antitank and 15th /21st Panzer. They activate 15th Panzer, which launches an attack against 1st Rifle Brigade of 2nd Armour. However, the result is no effect.

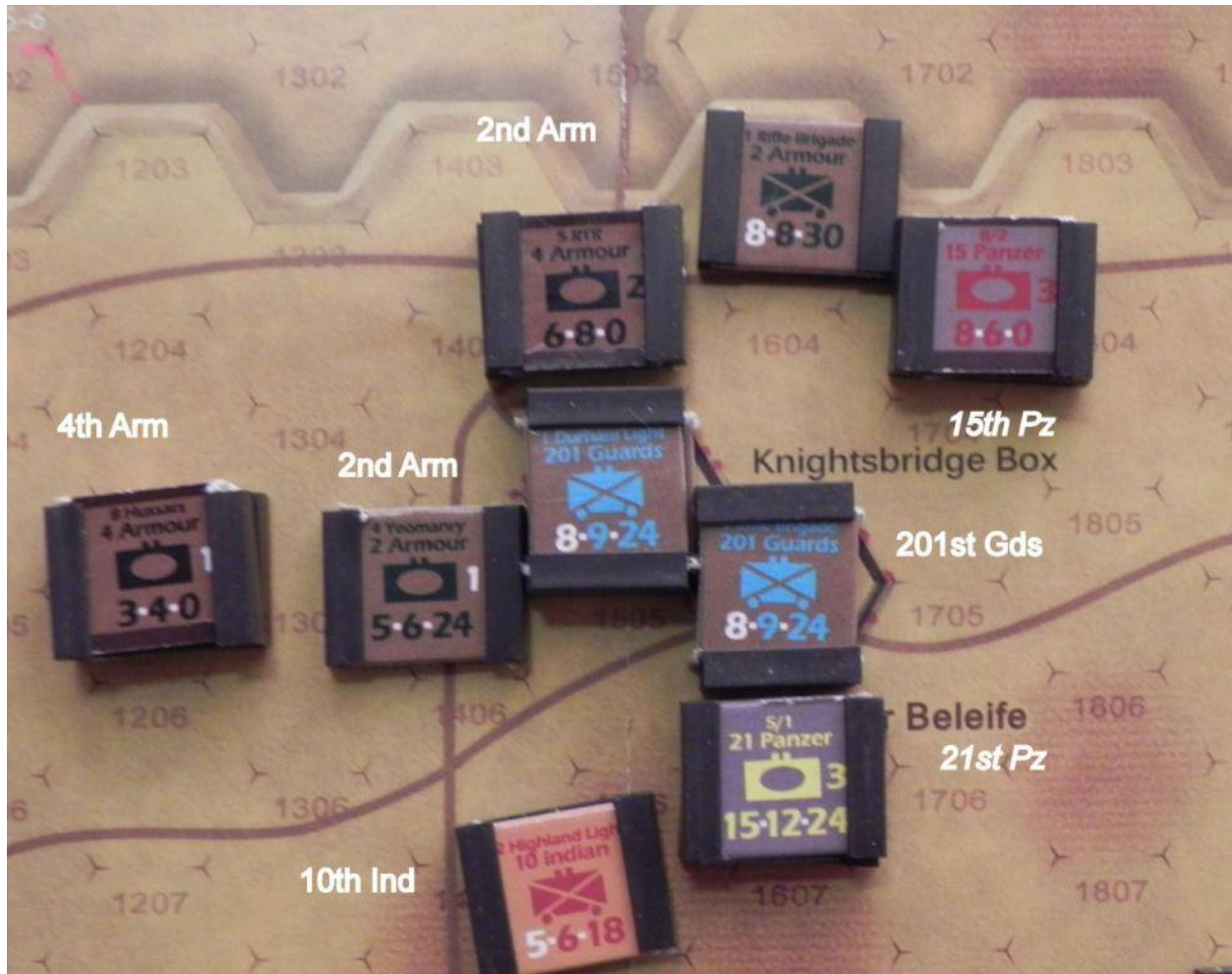

15th Panzer

The Allies draw Withdraw / Attack, Sandstorm, Extra Move, Airstrike, and Double Move. Why is the RAF so fond of sandstorms? The Allies activate the two remaining units of 150 Infantry (for the first time in the game!) to move them in the direction of the fighting, in case they prove useful next turn.

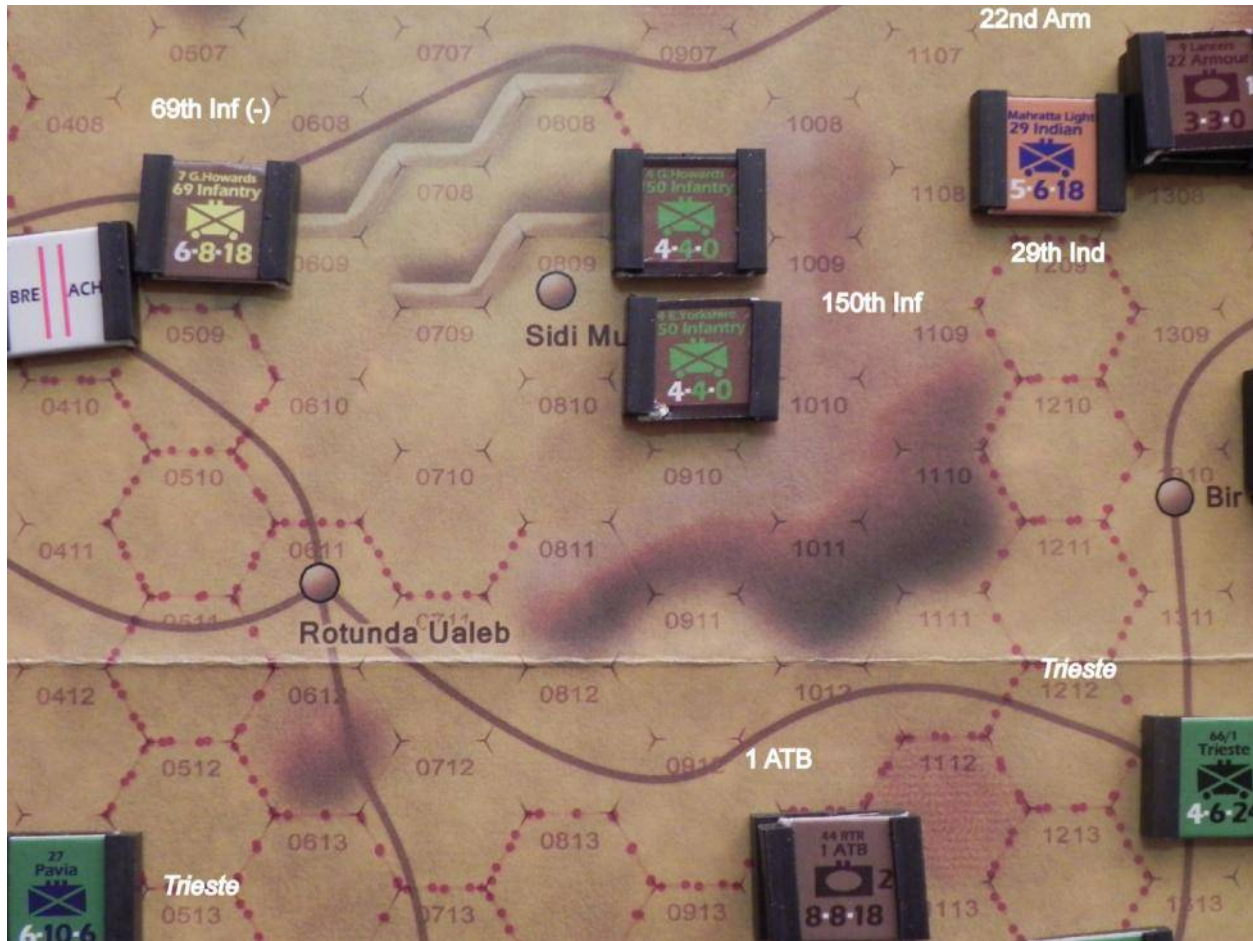

Allied Double Move

The Axis draws *15th / 21st Panzer*. They choose to activate *21st Panzer*. First, they move their antitank unit around the *Ariete* position and adjacent to 32 ATB. Then *5/1 Panzer* pulls away from its position by Knightsbridge and attacks 32 ATB and 2 Highland Light/10th Indian, supported by the antitank unit and *Ariete*. They also play their Antitank chit. The result is no effect, but 4 RTR loses a step from the chit. The Axis then bring in *5/2 Panzer* to repeat the attack. This time they get /*RD. The Allies take the step loss by eliminating the Indian unit. 32 ATB retreats and is disrupted. The panzers advance after combat.

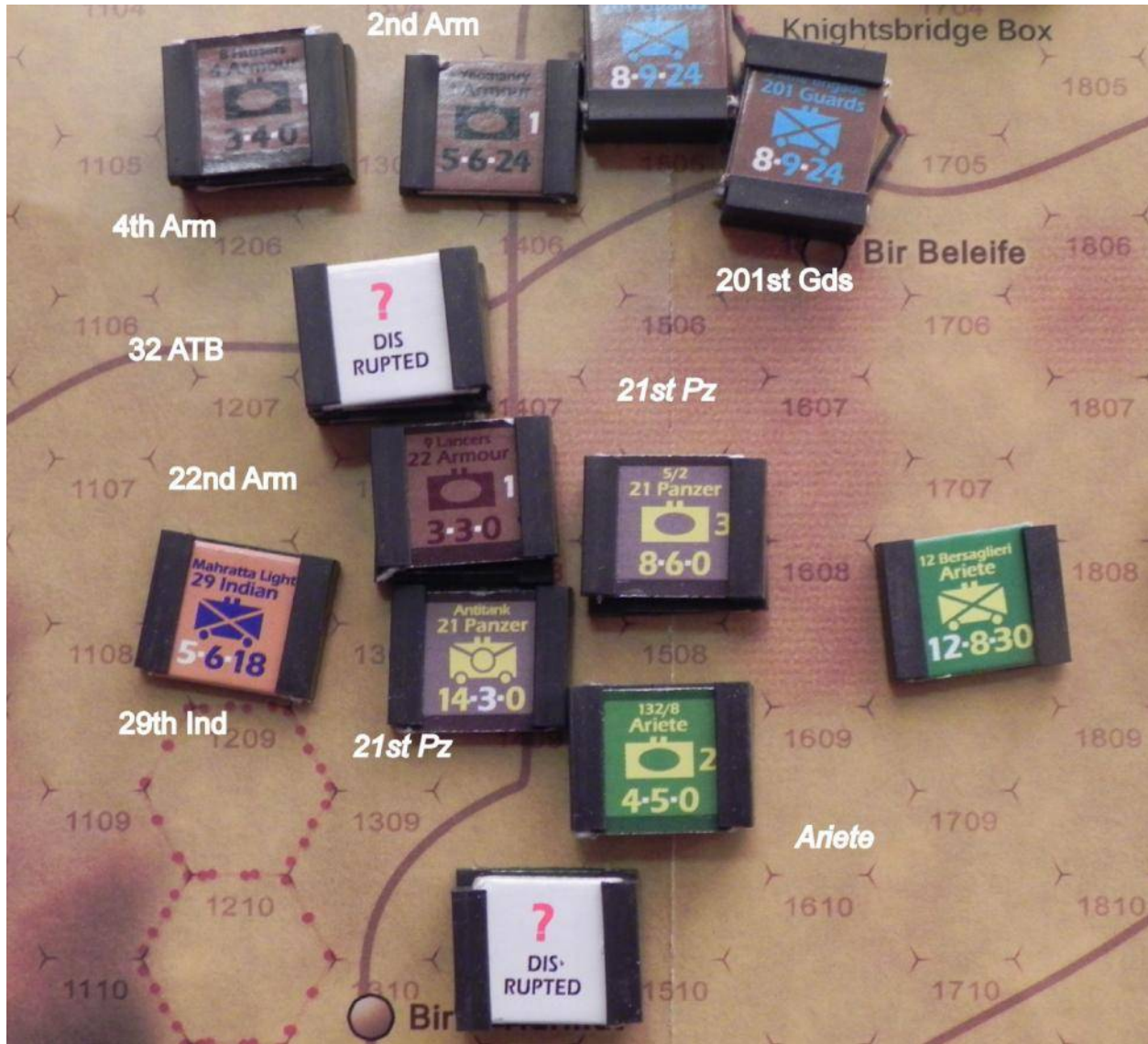

21st Panzer

The Allies draw 1 ATB. First, they use Withdraw / Attack to remove the now-nonexistent 10th Indian from the game. Then they move 8 RTR out of the minefield where it had been keeping an eye on *Pavia* and down the road in the direction of *Knightsbridge*. Then they move the other two 1 ATB battalions to try to dislodge the *Trieste* battalions guarding the minefield breaches in the triangle. Despite playing the Combat chit, the attack is unsuccessful, and the British units must retreat. Finally, the Allies play Extra Move to activate 4 Green Howards / 150 Infantry to move up and attack the vulnerable *21st Panzer* antitank unit. The result is /RD. The German unit retreats behind *Ariete* and is disrupted. That's a disappointment to the Allies, but at least it won't be helping in any attack on 22nd Armour this turn.

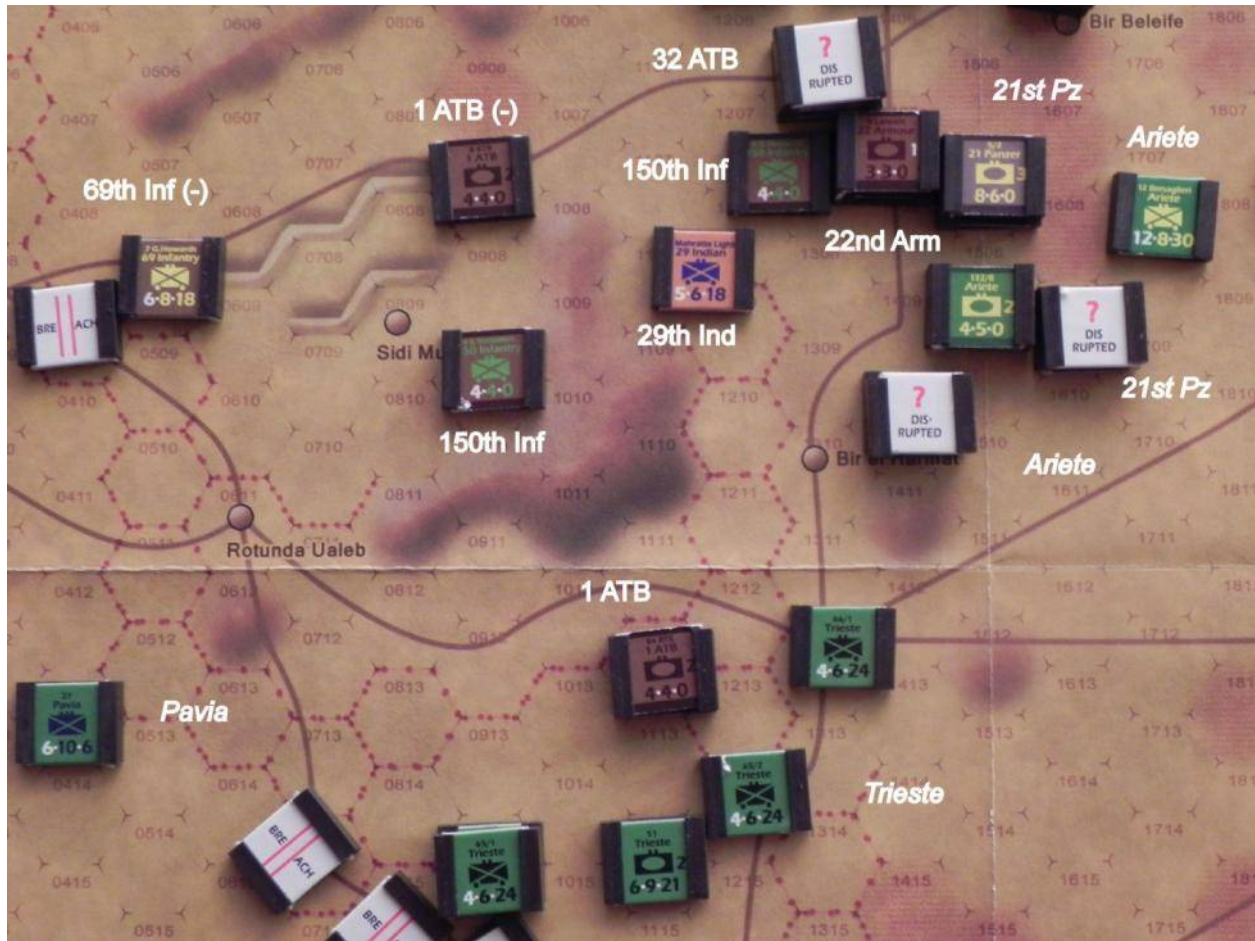

1 Army Tank Brigade

The Axis draws Extra Move, Sandstorm, Armor Replacement, Airstrike, Combat, and *15th / 21st Panzer*. So both air forces like sand in the air. Despite the weather, the Axis commits *21st Panzer* to attack *22nd Armour*. It's 3:1, -2 for light attack, +1 for Combat, -1 for terrain. *5/1* leads the attack, supported by *5/2*. They do fairly well, forcing the British to retreat. Both units advance after combat, and then *5/2* activates to attack the disrupted *32nd ATB*, supported by *5/2*. It's a 3:2 attack, and the DRMs for disruption and light attack cancel. This time, though, the Germans must retreat, and they wind up back where they started from.

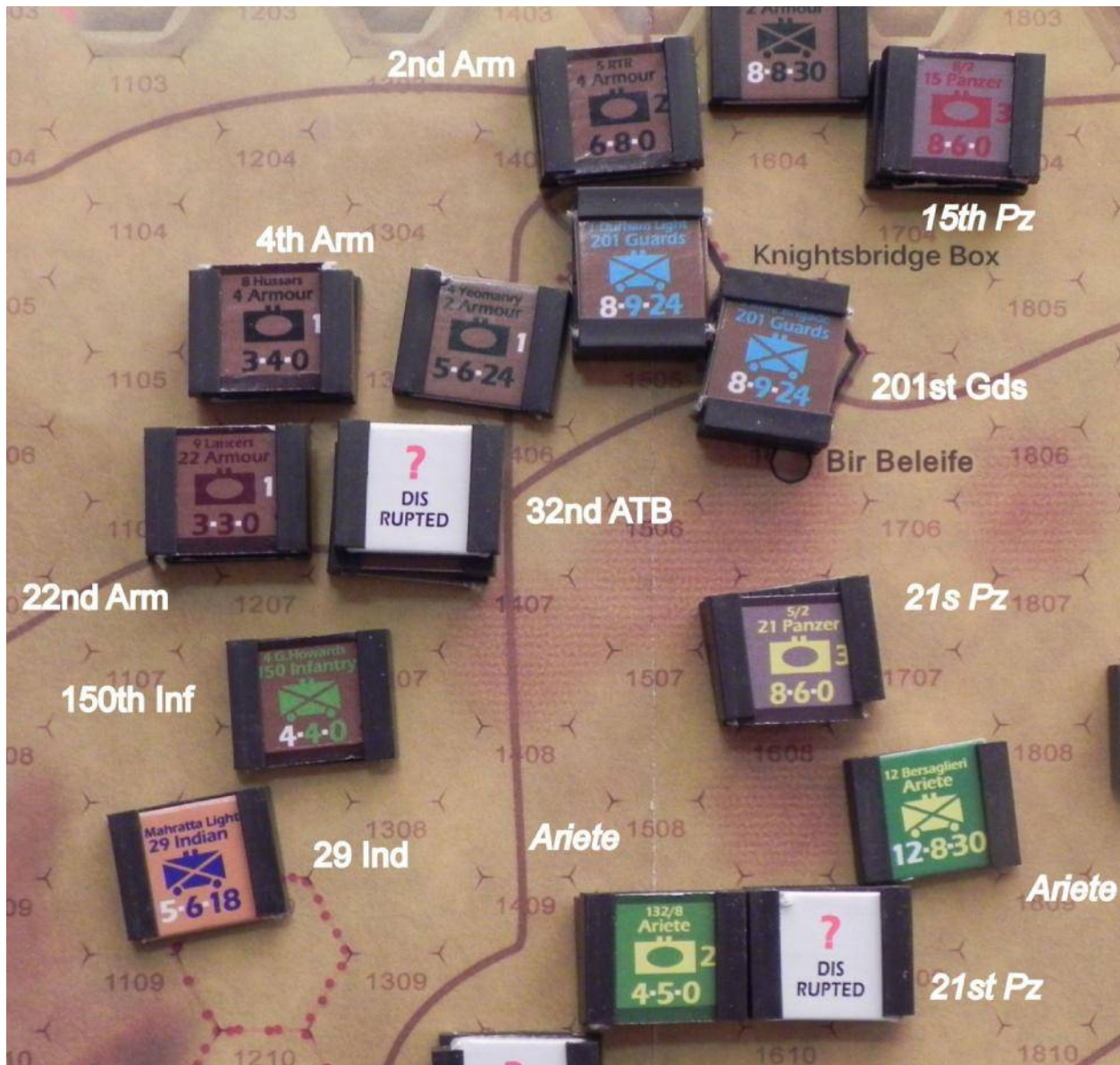

21st Panzer Second Activation

For their last activation, the Allies draw 32nd ATB, which is disrupted. They first use their Armour Replacement to bring 4th Yeomanry / 2nd Armour up to strength. Then they activate 8th RTR / 1st ATB and send it down to join the rest of its brigade, in case there is a chance to hurt *Trieste* next turn.

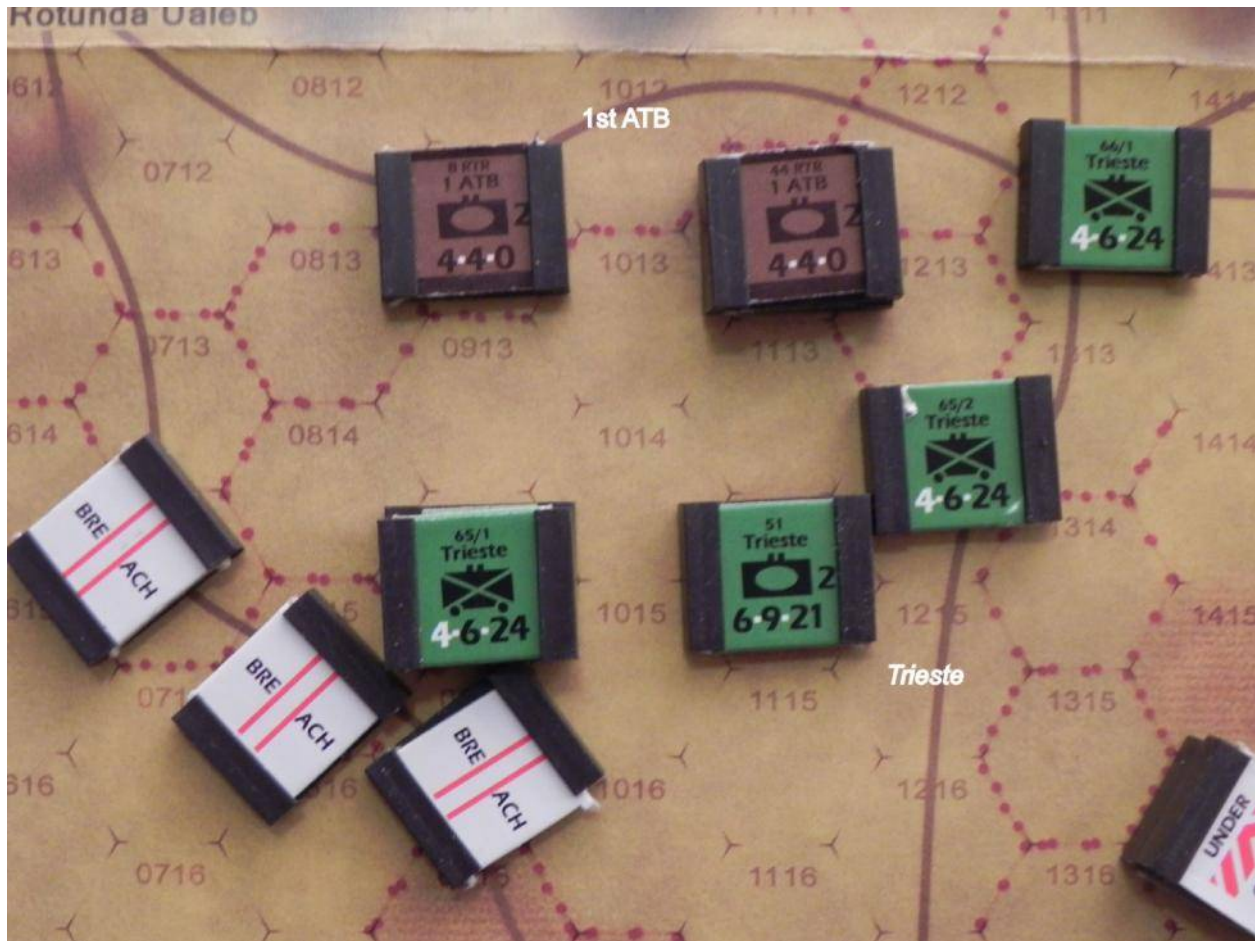

8th RTR / 1 ATB

The Axis draws *Ariete / Trieste*. They use Armour Replacement to bring back *132/10 Tank* at reduced strength. Then they activate *Ariete* and use Extra Move to activate *5/2/21 Panzer*. *132/10* makes an epic trek from the map edge to join *132/9* adjacent to 4th Green Howards / 150 Infantry. Then *5/2/21* provides the muscle for a 5:1 attack on the British infantry, supported by the Italian armor. Surprisingly, the Allies hold their ground. *Ariete* sends its infantry and antitank units to put a ring around the Knightsbridge box, to prevent 201st Guards from trying to get behind the Axis advance.

Gazala: The Cauldron

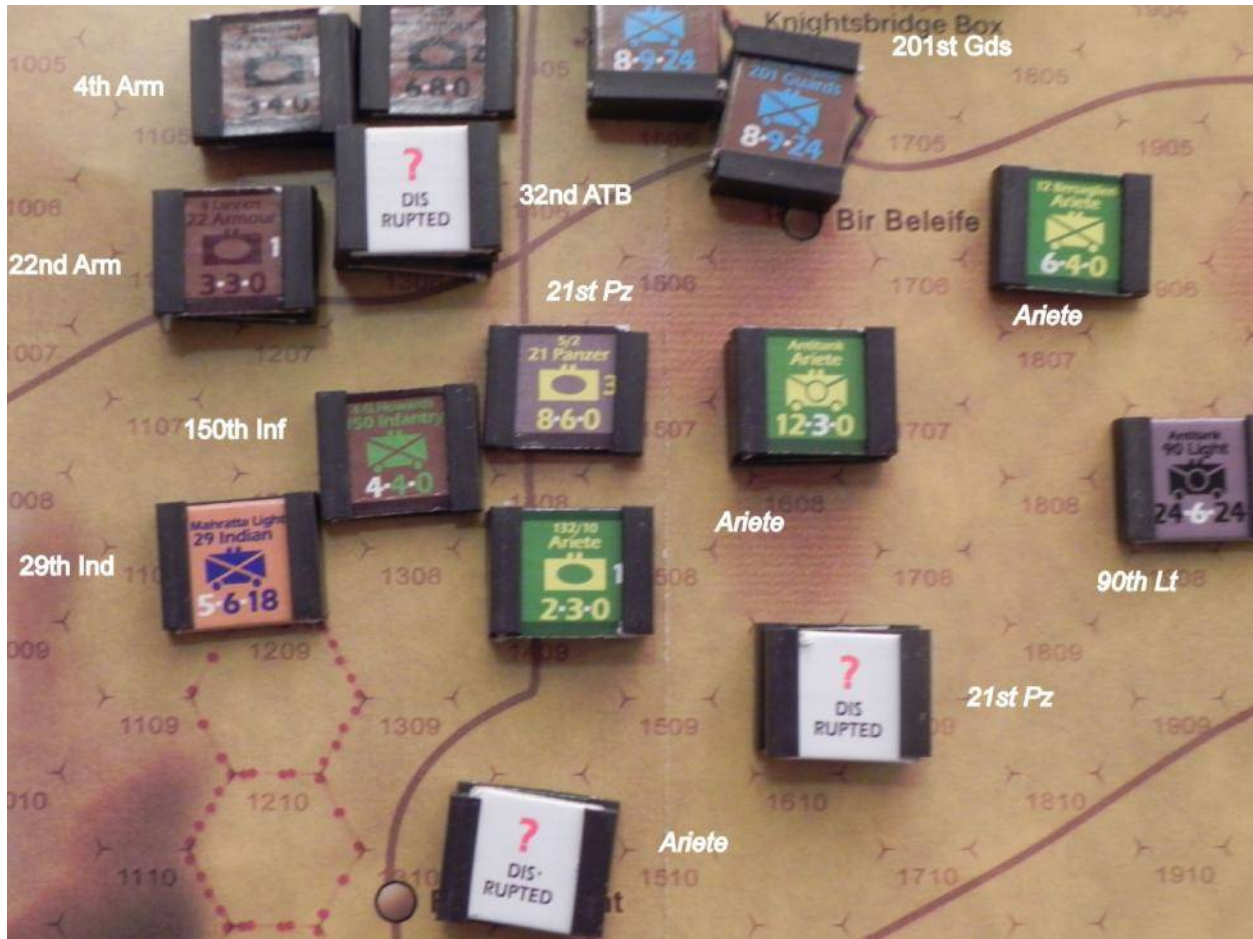

Ariete Second Activation

June 13-14

Both sides get 4 activations. The Allies have the same chits as the previous turn, but the Axis has one fewer *Ariete* / *Trieste*.

No reinforcements this turn.

The French garrison is out of supply for a second turn, which makes it isolated.

288/1-2/90th Light finishes its minefield breach, adding an extra hole for the Axis line of communications to flow through.

Gazala: The Cauldron

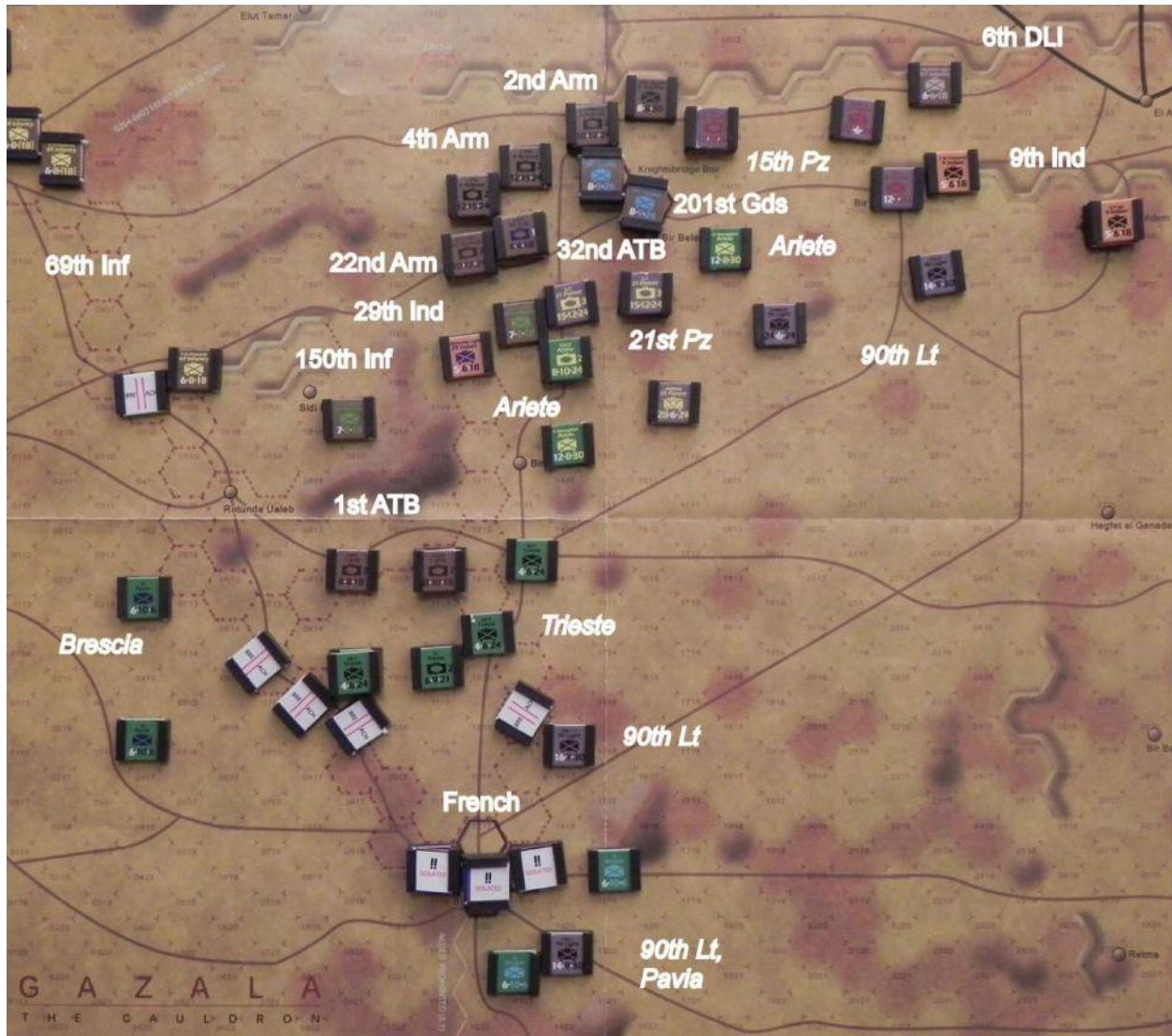

June 13-14 Minefield Phase

The Germans win the initiative roll.

The Axis draw Extra Move and *15th / 21st Panzer*. *5/1/21 Panzer* launches a heavy attack against 4th Green Howards / 150th Infantry, supported by Ariete. The British are forced to retreat. Then the *21st's* antitank unit moves adjacent to 32nd ATB and *5/2/21 Panzer* attacks with the AT guns in support. The result is an exchange. 32nd ATB takes the loss by reducing 7 RTR.

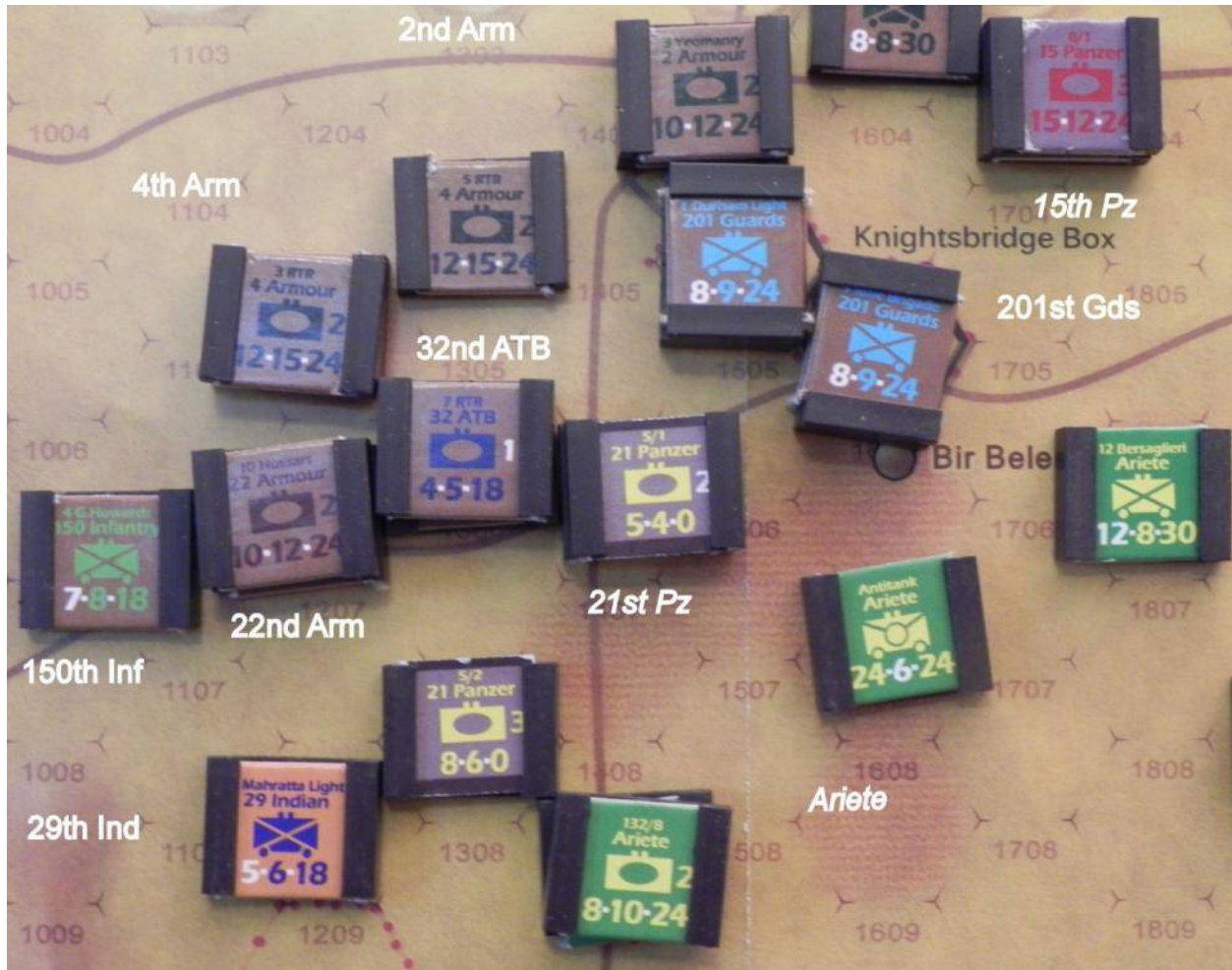

21st Panzer

The Allies draw Withdraw / Attack and then 2nd Armour. This brigade is facing *15th Panzer* but is too weak to attack when the Germans are still on their unactivated sides. They withdraw 1st Rifle Brigade from contact with the panzers and move it north of the escarpment. This will block the path north of the Knightsbridge Box even if the Germans succeed in dislodging 2nd Armour's tanks. These stay in place, and thus don't have to flip to their weaker sides.

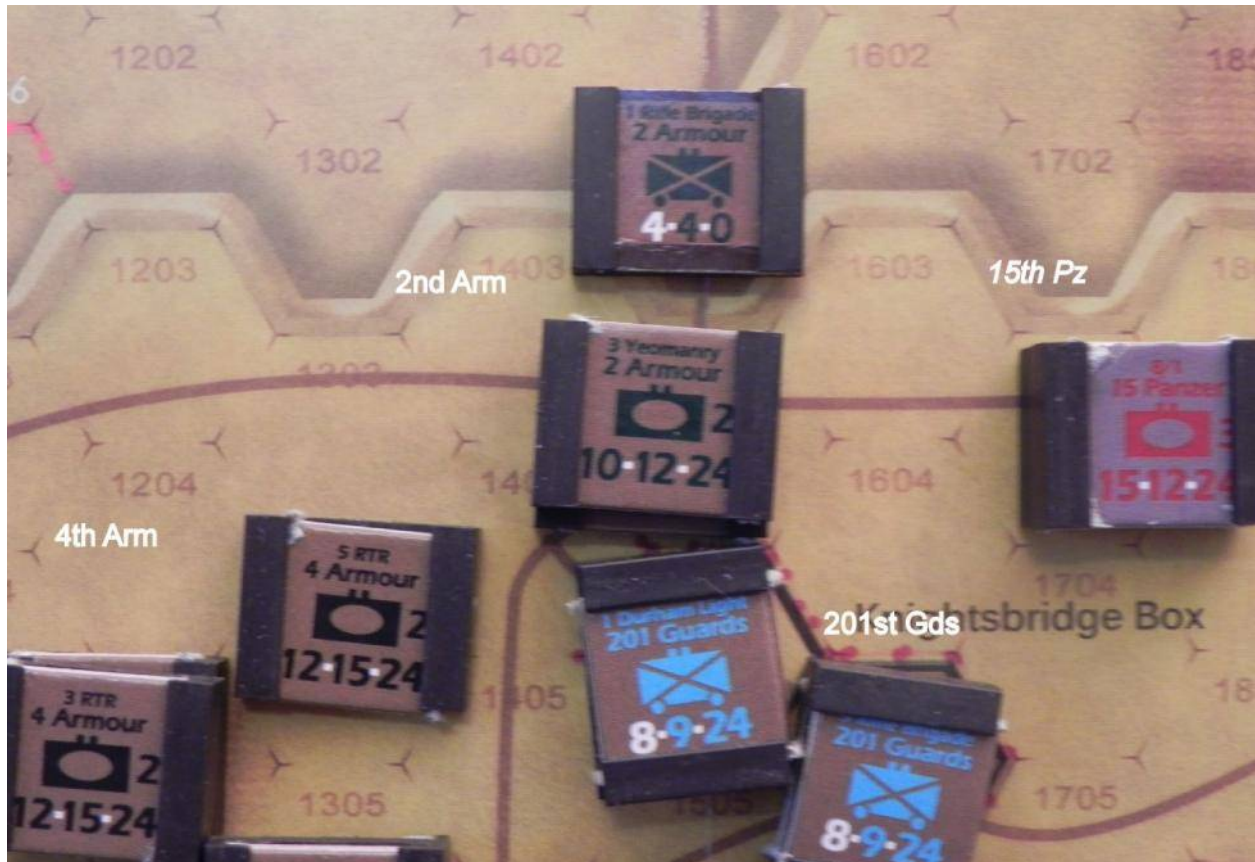

2nd Armour

The Axis draws *Ariete / Trieste*. *132/8/Ariete* advances and, with *5/2/21*'s support, attacks 29th Indian, eliminating it. *132/8* then swings around the British Armour and ends up just west of 4th Green Howards. The rest of *Ariete* follows, and *12 Bersaglieri* spearheads the attack. However, the Green Howards hold their ground, leaving one of the Italian stacks disrupted.

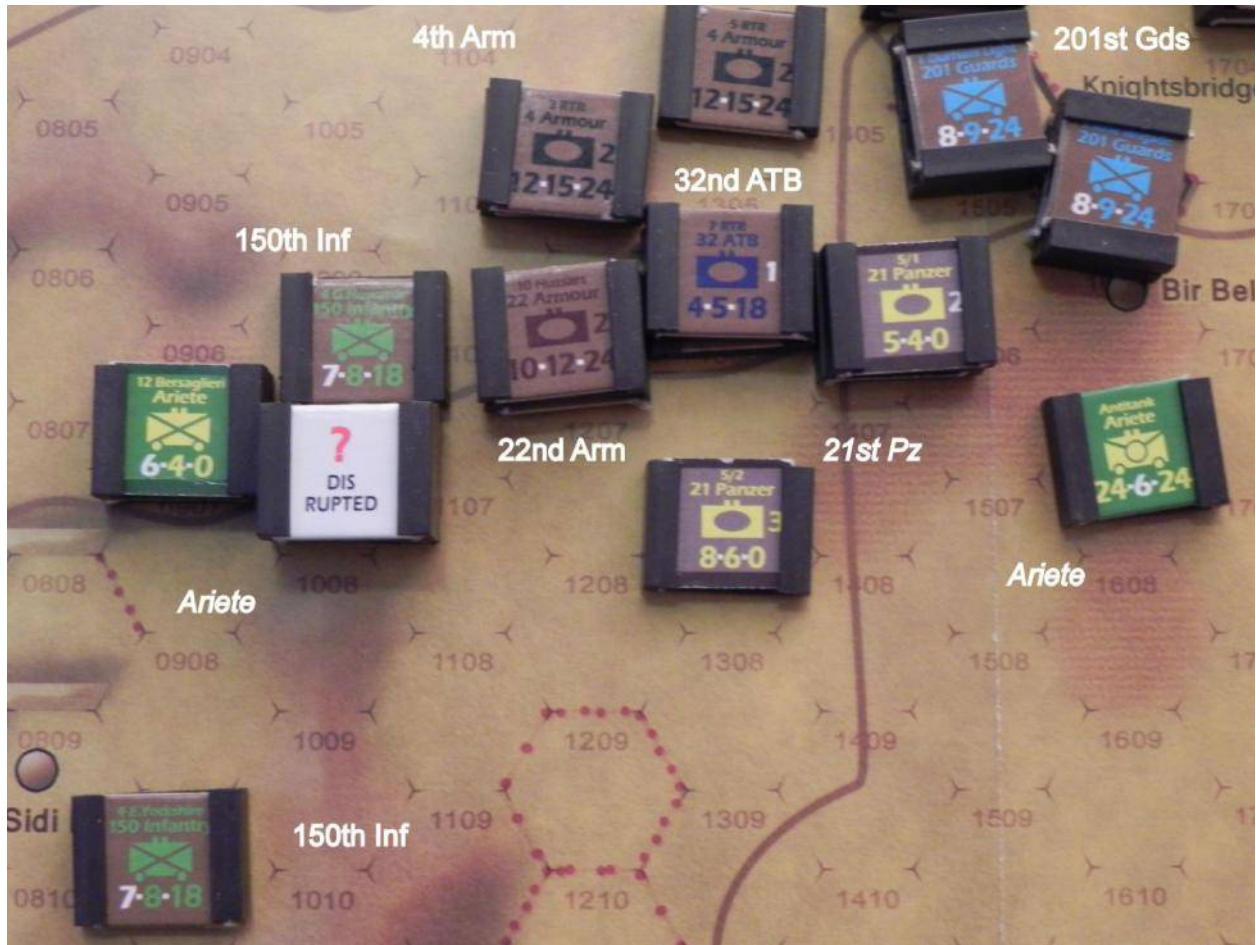

Ariete

The Allies draw Extra Move and Double Move. They use both chits to activate the two armour units of 2nd Armour plus 8 Hussars / 4th Armour to attack the disrupted *Ariete* units. The result is /*RD. *132/8 tank* is destroyed, and *12 Bersaglieri* must retreat. The Italians are now cut off by ZoCs and minefields, but, given that this is the last turn, that's probably not going to make much of a difference.

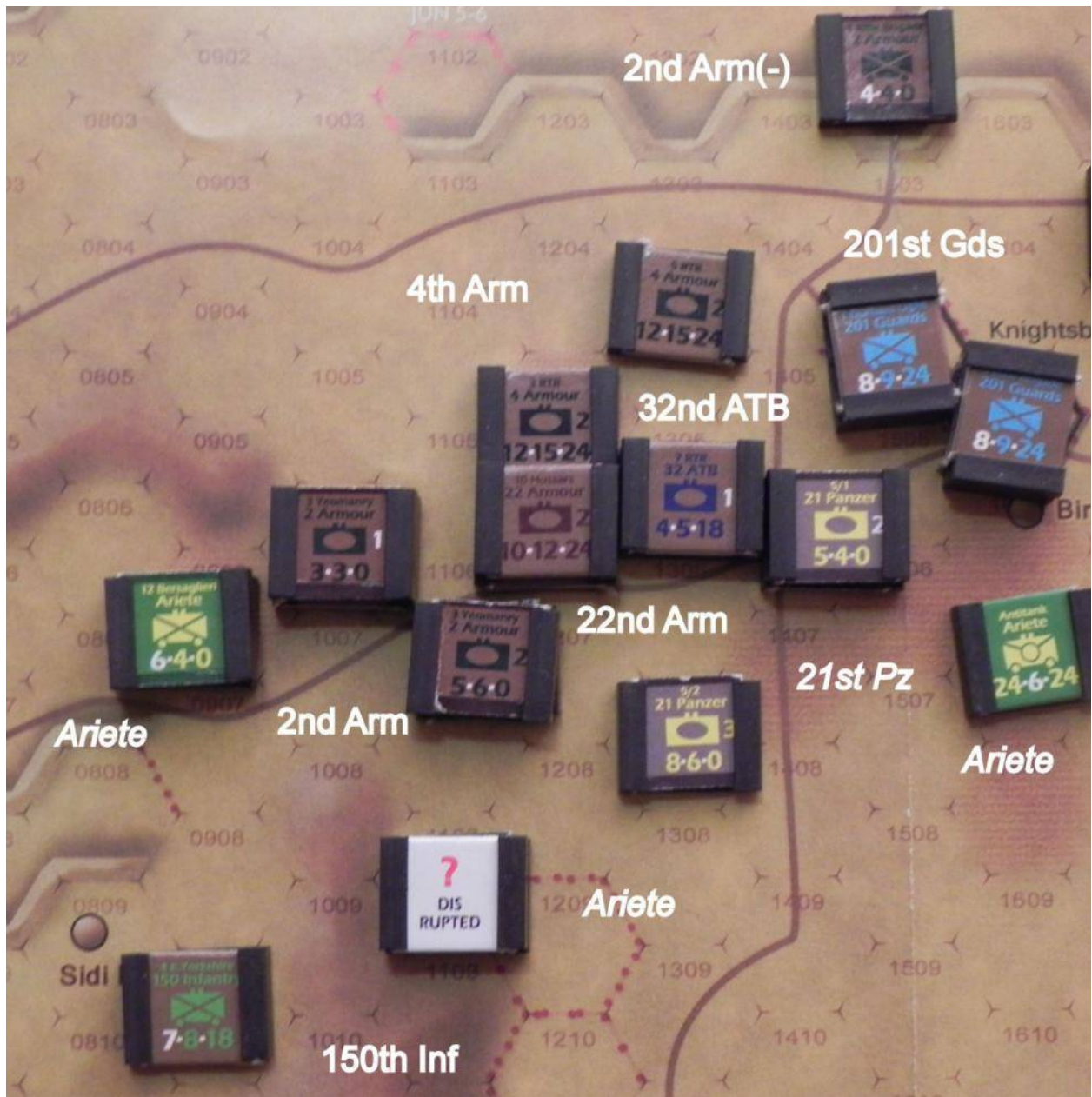

Double Move

The Germans draw Antitank, Combat, and *15th / 21st Panzer*. *5/1/21*, supported by the division's antitank unit, makes a heavy attack against *32 ATB*. The result is */*R*, which eliminates 7 RTR and sends 4 RTR reeling. Both German units advance after combat, which puts them adjacent to *22nd Armour*. Then *5/1/21* attacks *22nd Armour*, supported by the other two units. They add in *Combat* and *Antitank*. The result is */**, which, combined with *Antitank*, destroys the full strength *10 Hussars* and leaves the depleted *9 Lancers* alone in the hex. Finally, they use *Extra Move* to bring around *Ariete's* antitank unit to provide flank security and prevent another attack on the disrupted *5 Bersaglieri*.

Gazala: The Cauldron

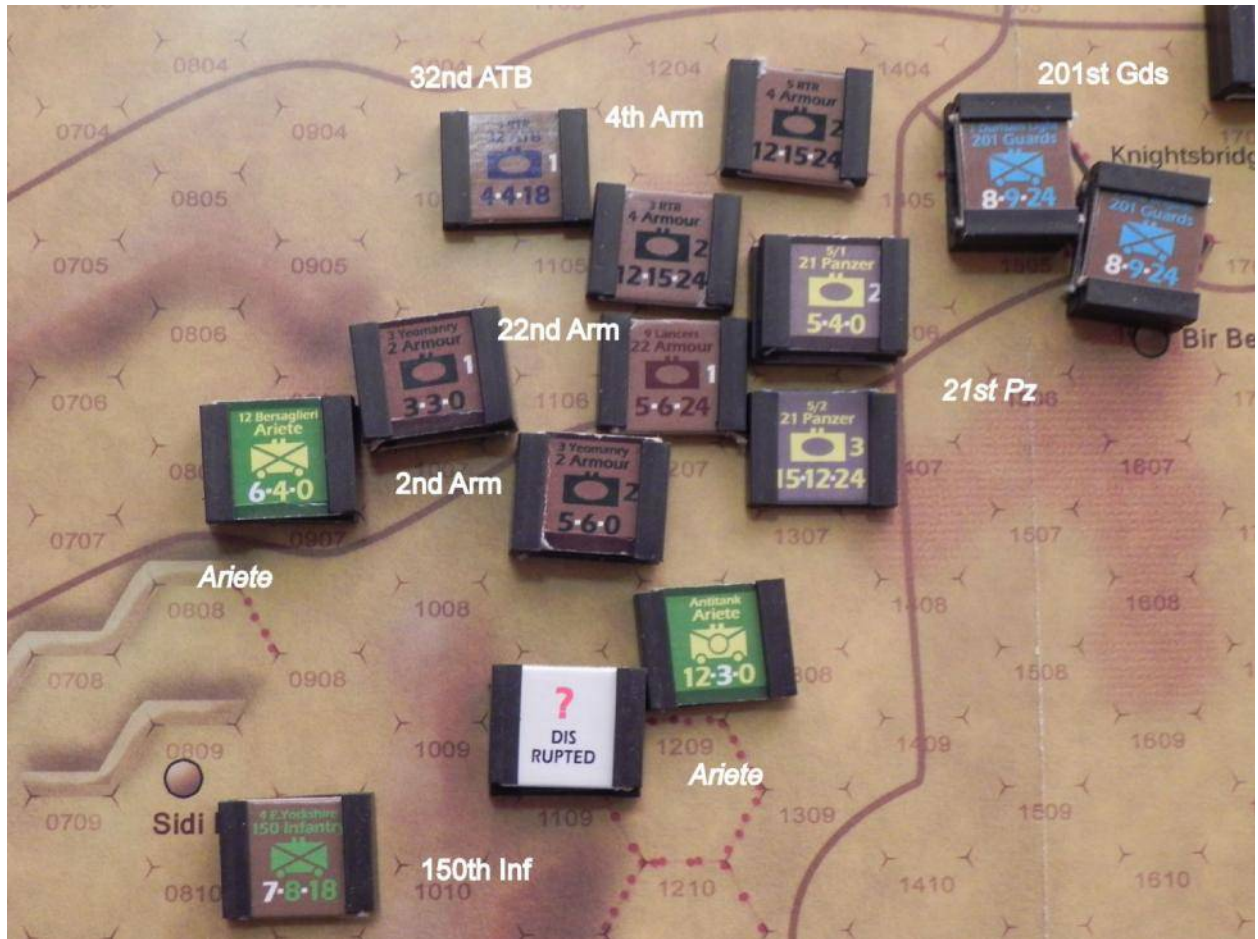

21st Panzer Second Activation

The Allies draw Combat and 22nd Armour. Unfortunately, that unit consists of only the depleted 9th Lancers. It withdraws from its exposed position and stacks with 4RTR of 4th Armour.

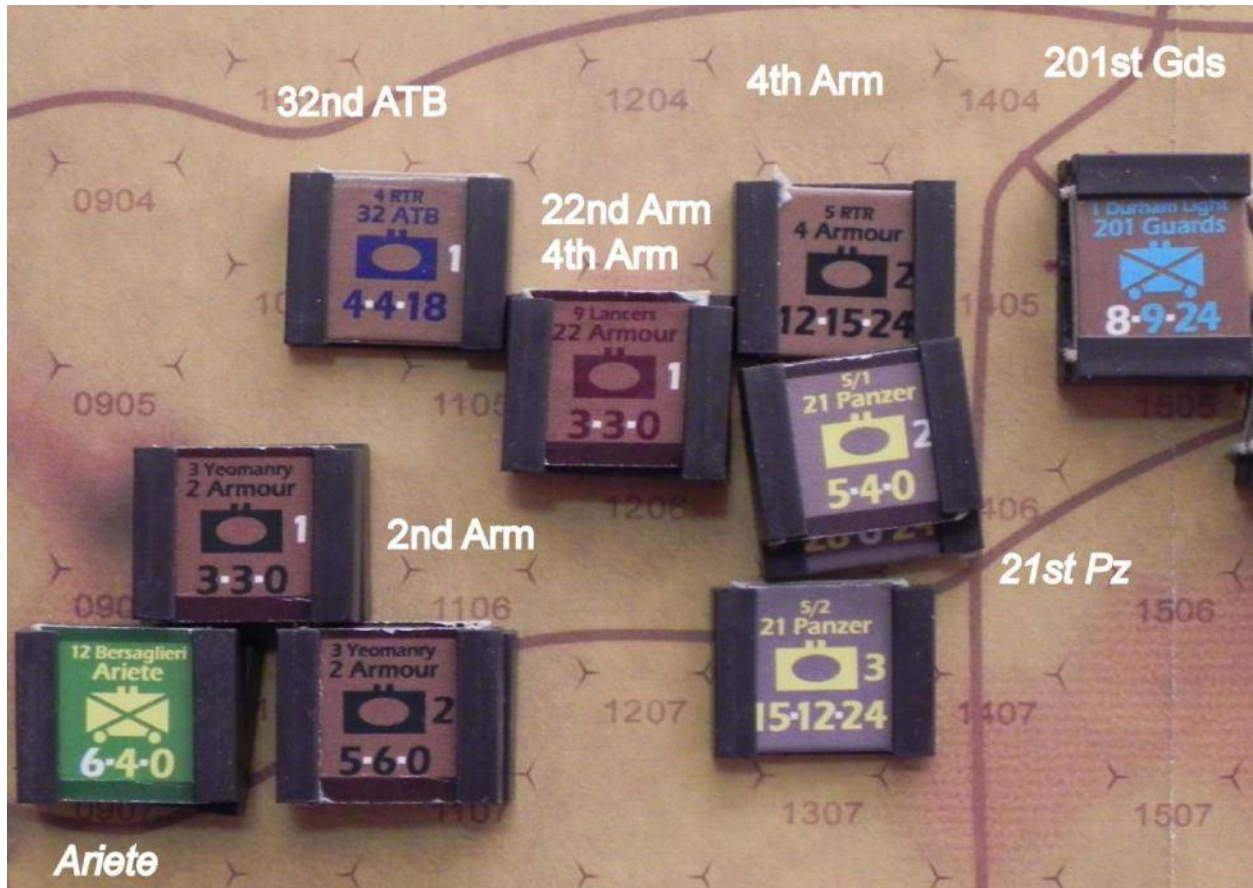

22nd Armour

The Axis draws *15th / 21st Panzer*. Since no formation may be activated more than twice per turn, the Axis may not activate *21st Panzer* again. *15th Panzer* attempts something spectacular. First, *8/1 Panzer* zooms east and attacks *9th Durham Light Infantry*. The 2:1 attack is an exchange, which eliminates the British unit. *8/1* moves one hex south to end its activation adjacent to *2 W Yorkshire / 9th Indian*. Then *8/2* joins *8/1* and launches an attack against *2 W Yorkshire*. The Allied unit is trapped against the escarpment and can't retreat, but it gets off with a disruption. *8/2* keeps moving, ending its activation in the victory point hex of *El Adem*. Then *115/1/21 Infantry* comes around the escarpment and attacks the Allied unit again, supported by *8/1*. This time, the defender is eliminated. *115/1/21* keeps moving, ending just north of the *El Adem Box*, to keep the remaining *9th Indian* units from causing trouble. Meanwhile, the division's antitank unit moves a little west to interdict the roads from the *Knightsbridge Box*, to keep the panzers from being put out of supply.

Gazala: The Cauldron

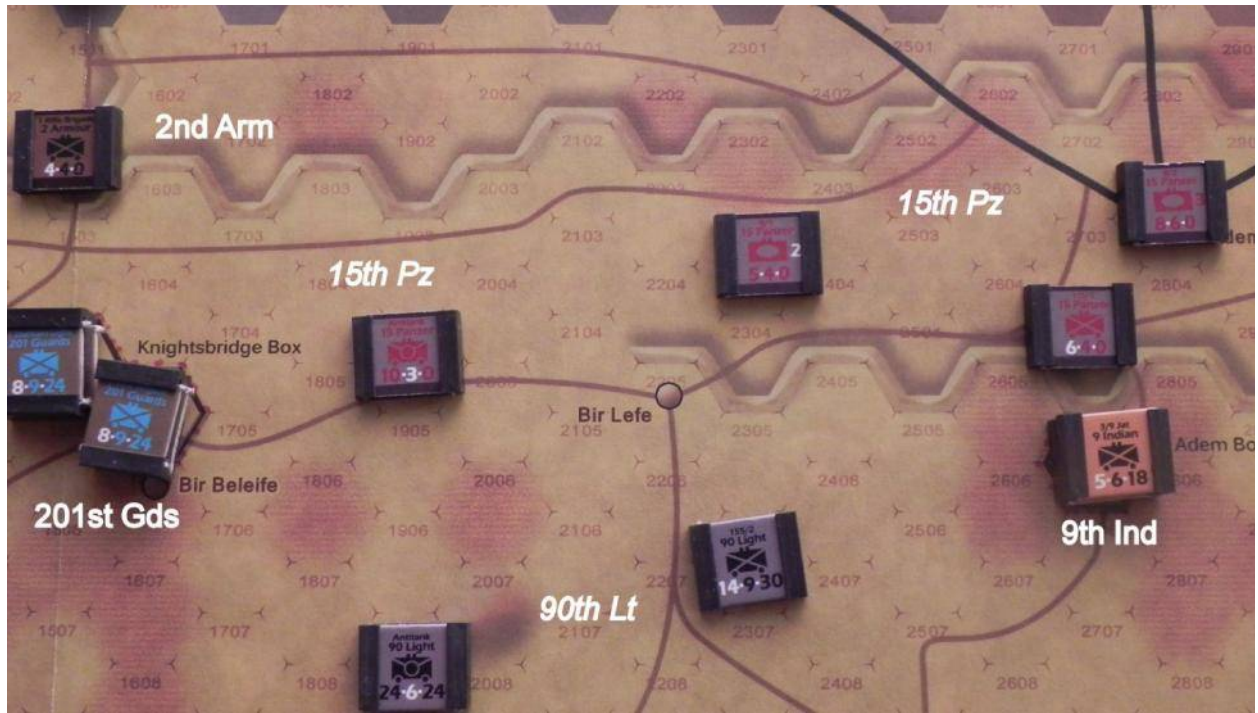

15th Panzer

For the last activation of the game, the Allies draw 1st ATB. Acting with all of its battalions together for the first time, it attacks the *Trieste* infantry holding the breached minefield. It's a 2:1 attack, +2 for the Combat chit. The result is /*RD, which eliminates one Italian unit and sends the other retreating through the breach, disrupted. If it weren't the end of the game, this would be a significant result, as it closes the Axis line of communication and reestablishes a supply line to the French. As it is, the only contribution is the victory points for eliminating the unit.

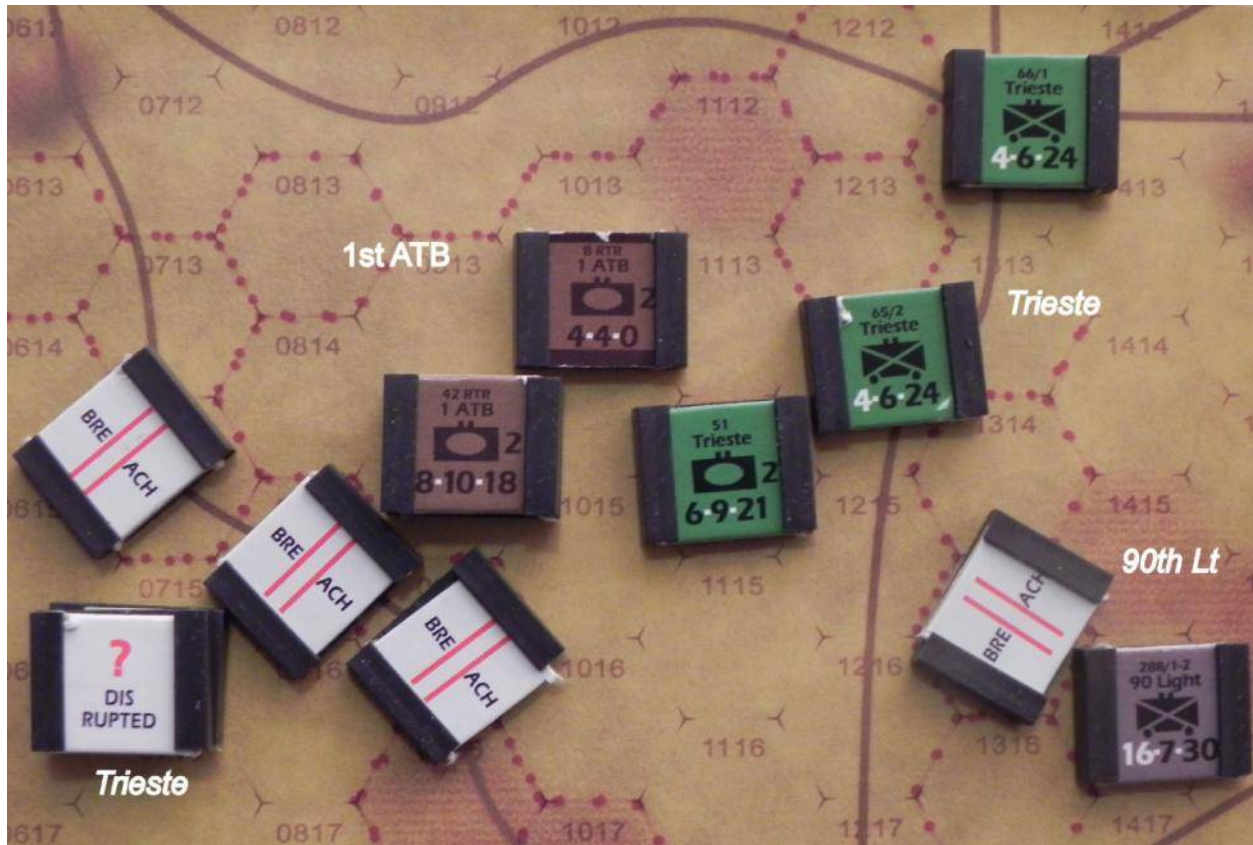

1st Army Tank Brigade

The Reckoning

The Axis started with 1 victory point. The Axis get one victory point for each Allied step eliminated, while the Allies get two for each Axis step. Comparing infantry losses on both sides, the Allies lost 18 steps, while the Axis lost 9, and so the victory points cancel. Replaced armour steps do not count towards losses, and so it's just a matter of counting up what's in the destroyed units box at the end of the game. The Axis lost 5 steps to the Allied 12, giving the Axis a net gain of 2 VP. The only geographic objective that the Axis achieved was to occupy El Adem for one turn (the last turn), which gives them 1 point. So, the Axis ends the game with $1+2+1 = 4$ VP. According to the rules, that's enough for a victory.

Gazala: The Cauldron

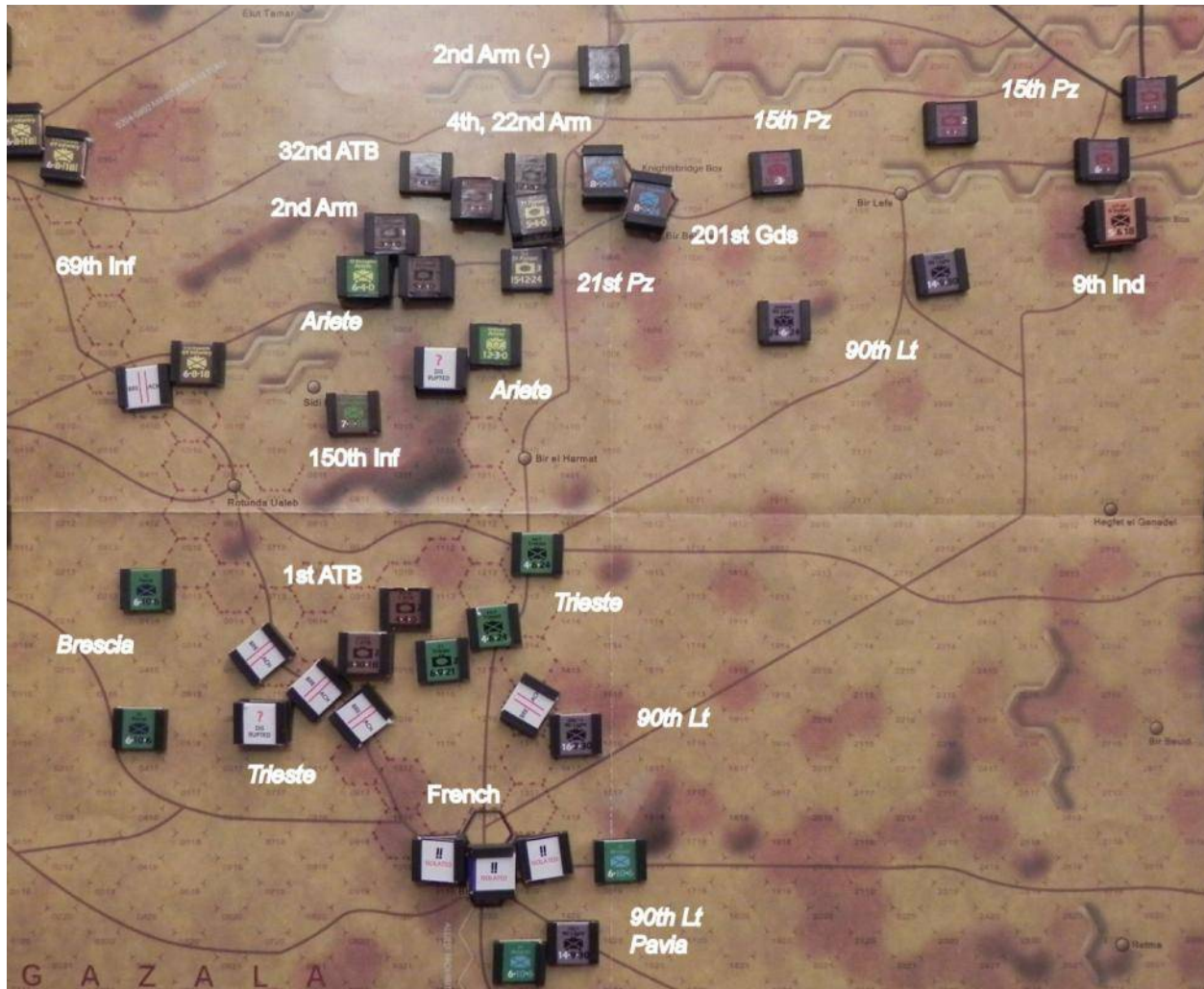

End of Game

It's pretty clear that I am no Rommel. On the other hand, perhaps I'm no Ritchie either. My plan was to ignore the fortified boxes in order to destroy the Allied forces and drive to the objectives on the edge of the map. I didn't achieve that, but I just barely eliminated enough units to eke out a victory. On the Allied side, it was more a matter of improvisation, looking for opportunities to slow down the panzers or put them out of supply. The Axis did have to keep an eye on their flanks and take care not to advance a narrow salient too far, to prevent the spearheads from being cut off.

Once again, I found this game system to be a lot of fun to play. The chit-pull mechanism adds a lot of chaos to the battlefield, and each side has the opportunity to react to enemy moves within the game turn. A powerful formation can set up a one-two punch that can really put the hurt on the other side, as the panzer formations did in the last turn of this game. The game does a good job of portraying command control and logistics constraints and the interaction between armor and infantry at this stage of the war.